

Tools of Geotechnical Investigation on Mars

Jakić, Michel

Master's thesis / Diplomski rad

2021

Degree Grantor / Ustanova koja je dodijelila akademski / stručni stupanj: **University of Rijeka, Faculty of Civil Engineering / Sveučilište u Rijeci, Građevinski fakultet**

Permanent link / Trajna poveznica: <https://um.nsk.hr/um:nbn:hr:157:300407>

Rights / Prava: [In copyright](#)/[Zaštićeno autorskim pravom.](#)

Download date / Datum preuzimanja: **2025-03-15**



Repository / Repozitorij:

[Repository of the University of Rijeka, Faculty of Civil Engineering - FCERI Repository](#)



image not found or type unknown



Michel Jakić BSc

Tools of geotechnical investigation on Mars

Master's Thesis

Submitted in fulfilment of the requirements for the degree of

Diplom-Ingenieurin

Master's programme Civil Engineering, Geotechnics and Hydraulics

at

Graz University of Technology

supervisors:

Univ.Prof. Dipl.Ing. Dr.Ing Thomas Marcher

Mag. Dr. Gernot Grömer (Austrian Space Forum)

Georg H. Erharter, BSc, MSc

Institute of Rock Mechanics and Tunnelling

Graz University of Technology

Graz, September 2021

AFFIDAVIT

I declare that I have authored this thesis independently, that I have not used other than the declared sources/resources, and that I have explicitly marked all material which has been quoted either literally or by content from the used sources. The text document uploaded to TUGRAZonline is identical to the present master's thesis.

Date

A handwritten signature in black ink, appearing to read 'Jaliv', is written above a horizontal line.

Signature

Acknowledgements

I am particularly grateful for the assistance given by following people:

My mentors MSc Georg Hermann Erharter, dr. Gernot Grömer and dr. Thomas Marcher for providing advices and guiding me during this period.

Dr. Gernot Grömer and Österreichisches Weltraum Forum (ÖWF) for giving me access to the donning process in their headquarters and opportunity to participate in Analog Mission Basic Training (AMBT) course.

Dr. Manfred Blümel and laboratory staff from the Institute of Rock Mechanics and Tunneling at the Technical University Graz for providing me access to laboratory equipment.

Quarry in Klöch for providing me basalt samples for my tests.

My first Engineering Geology professor and mentor of my bachelor thesis Dr. Petra Jagodnik for introducing me to the world of Engineering Geology and leading me in this direction.

My partner and my family for being there for me and supporting me.

All these people lead me into direction where I am today.

“Geologists have a saying - rocks remember.”

Neil Armstrong

Abstract

Crewed Mars missions are a big challenge in the 21st century starting from exploring the surface on Mars and search for life to building a habitable base. A thorough investigation needs to be done before building a base on Mars. That would include choosing specific geotechnical tools for investigation. It is important because before building every structure, even on Earth, we need to make soil and rock investigations so it can be properly constructed according to the location. Especially on Mars where we have limited access before habitat is constructed. Taking machines and tools to Mars is difficult and expensive, also some they might not work properly. Thus, it is necessary to make conversion or adaptation to these devices. The problem with moving them onto another planet like Mars is that if conversion and adaptation are not properly created, experiment results couldn't be compared between the planets. It is important to think about completely different conditions. Starting from different size, gravity of the planet, atmosphere, and lack of liquid water. Machines used in laboratory constructed on Earth mostly depend on H₂O to be able to work properly so they are not directly transferrable to Mars. Test execution and result analysis must be adapted to different boundary conditions. The main goal of this thesis is to establish a catalog of geotechnical tools that are suited for an application on Mars including descriptions and guidelines on how the test execution and result analysis should be adapted. Devices that are analyzed in this paper are made for usage on Earth and are not constructed and designed in consideration of the planetary differences.

Table of contents

1. Introduction.....	1
1.1. Methodology and workflow.....	2
2. Mars.....	3
2.1 Geography.....	3
2.2 Physical differences between Mars and Earth.....	3
2.3 Geology.....	4
2.3.1 Mars history.....	5
2.3.2 Volcanism on Mars.....	6
2.3.3 Rocks and sediments on Mars.....	7
2.3.3.1 Basalt.....	8
2.3.3.2 Meteorites from Mars.....	8
2.3.3.3 Clay minerals.....	9
2.4 Climate and environmental conditions.....	10
2.5 Site investigation of Mars and Moon.....	12
2.5.1 Structure from motion Photogrammetry.....	12
2.5.2 Missions to Moon; Apollo 12, Apollo 16 and Apollo 17.....	13
2.5.3 Robots on Mars- equipment.....	14
2.5.3.1 Rover Curiosity.....	15
2.5.3.2 Rover Perseverance with small helicopter Ingenuity.....	17
2.5.4 Tools used in AMADEE missions by ÖWF.....	18
3. Site investigation on Earth.....	20
3.1 Characterization of soils.....	21
3.1.1 Geotechnical description of soils.....	21
3.1.2 Grain size analysis.....	22
3.1.2 Standard penetration test.....	24
3.1.3 Static cone penetration.....	26
3.1.4 Field Vane test.....	28
3.1.5 Pressuremeter test.....	29
3.2 Characterization of rocks.....	31
3.2.1 Tests conducted in laboratory and on-site.....	31
3.2.1.1 Schmidt hammer test.....	31
3.2.1.2 Shear strength test on discontinuities.....	32
3.2.1.3 Tilt test.....	33
3.2.1.4 P-wave velocity test.....	33
3.2.1.5 Equotip.....	35

3.2.1.6	Geologist hammer	36
3.2.2	Tests conducted in laboratory	37
3.2.2.1	Brazilian test	37
3.2.2.2	Point load test	37
3.2.2.3	Cerchar abrasivity test	42
3.3.	Classification of rock mass.....	43
3.4.	Mineralogical investigation	45
3.4.1	Raman Spectroscopy.....	45
4.	Potential problems in Martian conditions.....	46
4.1.	Characterization of soils.....	46
4.2.	Characterization of rocks	48
5.	Laboratory investigation	52
5.1.	Material sampling.....	52
5.2	Methods of investigation	53
5.3	P-wave velocity test results.....	53
5.3.1.	P-wave velocity result interpretation.....	56
5.4	Schmidt hammer test results.....	56
5.4.1	Schmidt hammer test result interpretation.....	58
5.5	Point Load Test results	59
5.5.1	Point Load Test result interpretation	61
6.	Discussion	62
7.	Conclusion and Outlook	65
	Publication bibliography	66

1. Introduction

Exploration of Mars started in the early ages of humankind in that time Mars was the red planet associated with war, knowledge of the Mars was limited to only observing its color. Early telescopic investigations started in the beginning of 17th century and in 20th century started more advanced Mars explorations that included spacecrafts (A. P. Rossi and S. Gasselt 2010). With technological progress of today's world came more interest in Mars exploration.

Analyzing conditions is important step in tool and machine preparation, geology of different planet needs to be taken into consideration like different climate and environmental conditions going from different size, lower gravity and the biggest difference of them is lack of liquid water. Important aspect is that humans could not survive these conditions without life support and specialized habitats. To make colonization of Mars possible more research needs to be done and important questions need to be answered: what information's are important and relevant before going there, how to get them, what tools to bring, and if so, how to adapt them to different conditions of another planet. It is very complex and difficult task and it will take long time and effort to get there. This thesis answers on question *"what tools to bring"*, *"what are possible problems"* and *"what needs to be taken into consideration when used on Mars"*.

For that colonies on Mars to be possible more research on Terrestrial equipment is needed, and adaptation for Martian conditions. This thesis is focused on some tools that could be used one day for on-site Martian exploration. Choosing tools for geotechnical investigation of Mars's surface are based on whether it uses water and saturated samples, size of the machine and how easily it can be adapted. Temperature dependency experiments are done in order to see how important it is in results when rock sample changes temperature, since temperatures on Mars can be from 25°C to -150°C, so it is one of the important factors to think about when analyzing results.

There are already some tools that are used on Mars sent on rovers, they are used remotely from Earth. Rovers are equipped with chosen tools and machines from laboratories on Earth. The first operating rover on the surface of Mars was Sojourner on 04. July 1997, delivered with U.S. spacecraft "Mars Pathfinder" that rover was "proof of concept" for technologies of that time (NASA). After that NASA landed 4 more rovers on Mars Spirit (landed on 04. January 2004), Opportunity (landed on 25. January 2004), Curiosity (landed on 06. August 2012), and Perseverance with Ingenuity (landed on 18. February 2021) (NASA).

This thesis is written with close cooperation with Austrian Space Forum. Austrian space forum (ÖWF Österreichisches Weltraum Forum) is institution in Innsbruck, Austria and they are conducting Mars analog missions in cooperation with national and international institutions for science and space industry (ÖWF). They shared information about Analog Mars Missions and provided me access to the donning process of the Aouda suit and because of that I gained more insight into movement possibilities of Astronaut when fully equipped.

With all that information about conditions, geology, astronaut's movement possibilities and tools, combined decision needs to be done, since not all geotechnical tools can be brought to Mars. Before making that decision tests need to be done on chosen tools and machines. Because of that I conducted a few experiments with changing temperature of the samples so I can show that it is also important aspect when conducting experiments and that it can affect results if samples are not stored properly. If temperature changes properties will not be the same.

1.1. Methodology and workflow

In first part of this paper, I gave short literature background starting from Mars geography and physical differences between Mars and Earth, overview of Martian history, volcanoes and minerals. I described climate and environmental conditions, used tools for Mars investigation, rovers Perseverance and Curiosity. I explained important part that Austrian Space forum has in preparation for humans on Mars. Second part refers to Tools for site investigation of Earth, all these tools are already in use and I just compiled their descriptions into one paper.

Important part of my work was to understand Martian conditions, and human possibilities during EVA missions. Humans can't survive on Mars without life support and for that we need suit that is heavy and restricts human movement possibilities, also we have to be careful handling around suit so human inside is not in any kind of danger, any sharp objects need to be handled carefully. If suit would rupture somewhere human would not be safe anymore, and we can't afford that to happen.

For me to get a better understanding of astronaut's movement possibilities I visited Austrian space forum when they were performing donning process. There dr. Thomas Wijnen analog astronaut tried on movements in full analog astronaut suit, he was able to move more than I expected, also hand movement was quite unexpected, since gloves are very well made and that improved performance. Movement problems would be if astronauts would drop something on the floor, since bending and reaching objects from the floor is difficult, for that they have small grabbing hand. After witnessing donning process, I had much better understanding of test possibilities.

Third part is my investigation and thinking, here I considered and organized all those devices into tables and sort them into categories. I used binary grading system with additional short descriptions with explanation of the specific problems that might occur. There are three tables for soil testing devices and three tables for rock testing devices. Soil testing is divided in on-site tools/tests human operated, on-site devices that require rovers and laboratory tests conducted in habitat. Rock testing is divided in on site tools/tests conducted by humans, tests/devices conducted in habitat with big machinery and mineralogical testing. All of those devices are in some way affected by different conditions on Mars and all of them should be adapted in some way, except for the Geological hammer since it is a very simple tool and it can be used like is, but it would be easier for the astronauts if the grip is a bit thicker. Other tools/devices have to be adapted or results should be converted, depending on a device.

To show importance of temperature change and to confirm that it can change results I conducted tests on 3 different devices and presented results. Regarding the rock samples they would probably behave differently on Mars although their mineralogical content can be similar to Earth rocks, since they were created in different conditions, and their temperature is currently much lower than it is on Earth. At the end there is a short overview of all tools and devices with descriptions why they can or can't function on Mars and what are possible problems.

2. Mars

2.1 Geography

This paper is focused on two planets; Mars and Earth. Distance from Sun to Mars is 227,940,000 km. Mars has two moons named Phobos and Deimos. Main difference is planets size, Mars is smaller than Earth, figure 1 shows comparison of A Earth, B Mars and C Moon, Mars is about half the size of the Earth, on Earth land masses, oceans and clouds are visible (NASA Apollo 17 picture, 1972), Mars has high-altitude CO₂ ice clouds (ESA Rosetta Osiris image, 2007). Highest mountain on Mars is Olympus Mons and it is three times higher than Earth's Mount Everest. It is located in the Tharsis Montes region near equator. Olympus Mons is a shield volcano and it is relatively young (compared in the lifetime of solar system) volcano since some parts are around few million years old (NASA 2020).

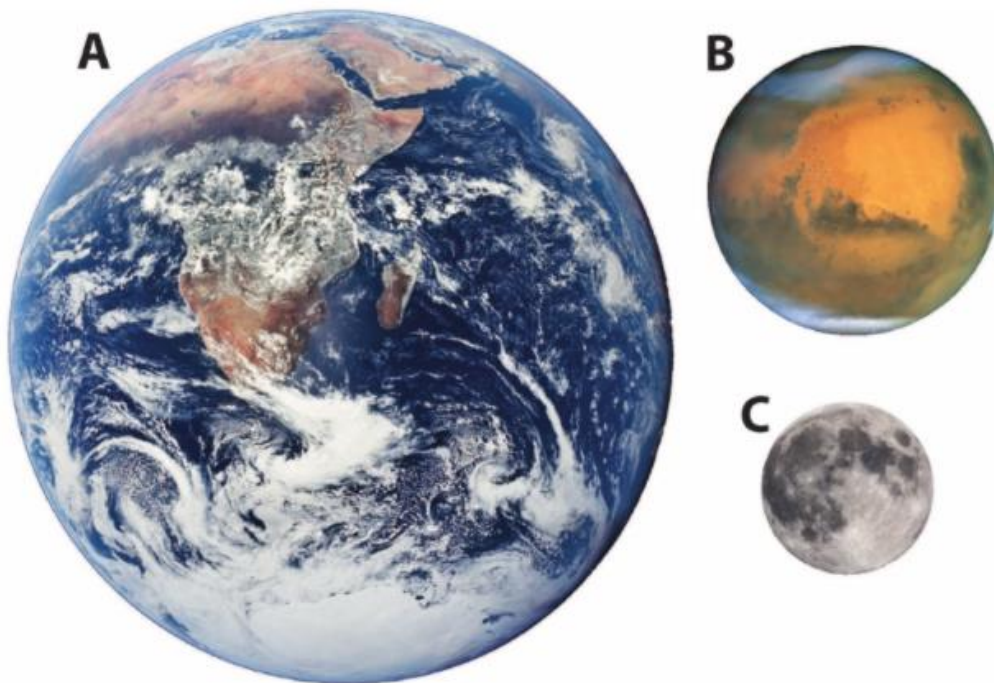

Figure 1 Size comparison of A Earth (NASA Apollo 17 picture, 1972), B Mars (ESA Rosetta Osiris image, 2007) and C Moon (NASA Clementine UVIS mosaic, 1994)

2.2 Physical differences between Mars and Earth

The surface of the Mars is about the same size as land on Earth ($149 \times 10^6 \text{ km}^2$), and has lower surface gravity of (3.711 m/s^2). Mars lacks magnetic fields and with that it is concluded that it has solid core today. According to Longhi et al., 1992; Stevenson, 2001; Zuber, 200 Mars does not have active plate tectonics as Earth (1). It is observed that northern hemisphere of the Mars is mainly smooth plains and southern has many craters with that it has deepest points from -7550m in Hellas Planitia to the 22640m on the top of Olympus Mons. These measures are referenced artificially to the equipotential of the truncated sphere's surface with radius of

3396km. Figure 2 shows this crustal dichotomy, and position of Hellas and Tharsis on map. It is important to notice here that highest peaks and lowest depths are almost perfect opposites.

Mars atmosphere is mainly carbon dioxide (95%), and contains nitrogen (3%), argon (1.6%) and traces of oxygen and water. Surface pressure depends on seasons and it can go from 0.7mbar at the top of Olympus Mons to the 14mbar at the deepest elevations. Temperature can range from diurnal surface temperatures of -150K (~ -423°C) on polar caps to the 300K (~ 26°C) in equatorial region, almost nowhere conditions for liquid water are met. Except in porespace with certain salt mixtures, water can be liquid at -60°C (A. P. Rossi and S. Gasselt 2010).

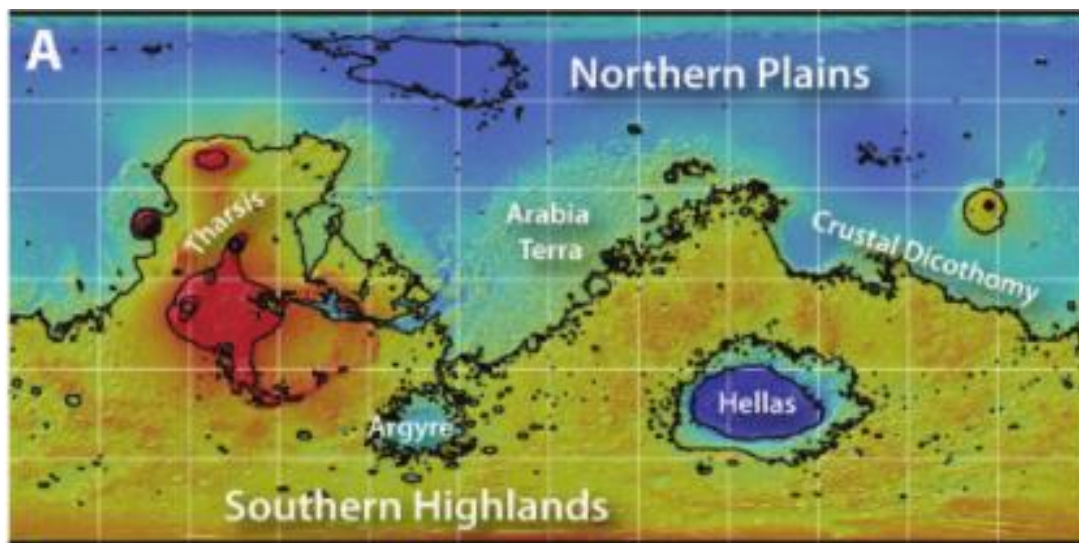

Figure 2 Crustal dichotomy on Mars, blue indicates low and red indicates high relief (NASA Mars Global Surveyor (MGS) Mars Orbiter Laser Altimeter (MOLA) data, Smith et al. 1999).

2.3 Geology

Mars is a desert planet with lower temperatures (-150°C) is result of greater distance from Sun (Earth distance to Sun: 151.61 million km, Mars: 250.06 million km (NASA)) and lack of thick atmosphere that can trap Sun heat and heat up the planet (A. P. Rossi and S. Gasselt 2010). Global mapping conducted by Mariner 9 orbiter in 1971 reveled the Martian surface, Mariner 9 observed younger volcanic plains and big volcanic constructs in the north, it also discovered that Mars has a canyon system and polar caps that change with seasons. Moreover, it found evidence that water existed in liquid state in history by observing geomorphic evidence of catastrophically big floods. Viking orbiters and the Mars Pathfinder provided much more information about Martian geology (Mineralogy society of America, J. J. Papike, editor 1998). Mars global Surveyor discovered gray hematite on the surface, a mineral that probably needed liquid water to form and it also discovered that sedimentary rocks existed on Mars (M.C. Malin and K.S. Edgett 2000).

Shaping of Mars surface coming from volcanic activity is similar to processes on Earth, also in period when Mars had liquid water, there were sedimentation processes, (e.g., Bibring et al., 2005; Bibring et al., 2006; Mustard et al., 2005) observations of sedimentation process on Mars are coming from mineralogy context.

Erosional landform can be interpreted as a consequence from fluid body movements. Chaotic terrains consist of mesas and blocky terrains on both can be seen signs of loss of material and mechanical wear, these conditions are observed in the boundary area of crustal dichotomy (A. P. Rossi and S. Gasselt 2010).

2.3.1 Mars history

The surface of the Mars is covered with rocks and sediments. Age of the rocks on Mars can be determined with two different methods. One is using radiogenic isotope age and the other considers specific positioning in environment, size, shape, atmosphere and formation of the crater size-frequency distribution. Figure 3 shows map with determined age of Mars surface, red territory is the oldest one and green ones are most recent. Time periods in Martian geological history are Noachian, Hesperian and Amazonian (A. P. Rossi and S. Gasselt 2010).

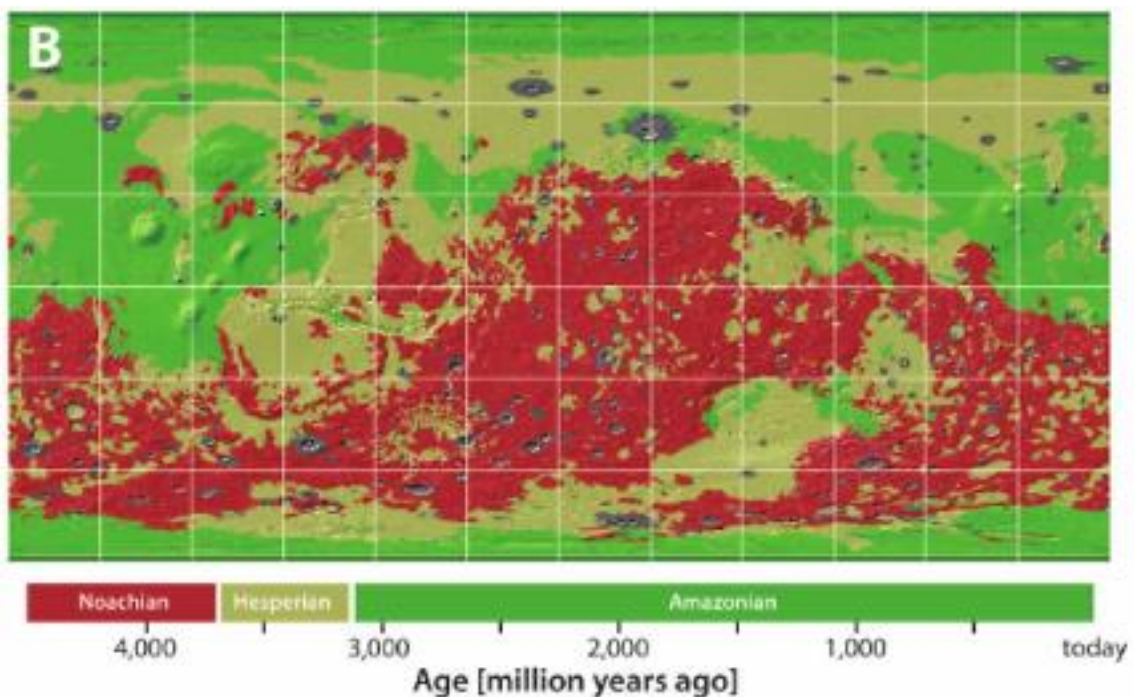

Figure 3 Simplified geological map of Mars indicating three main historical eras: Noachian, Hesperian and Amazonian (data from Scott and Tanaka (1986); Greeley and Guest (1987))

The oldest period of Martian geology is the Noachian period, and it is older than 3.97 Gyr to the 3.74 Gyr (Tanaka et al., 1992; Hartmann and Neukum 2001). Characteristic of this period are large volcanic activity in Tharsis region, global tectonic movements and valley formations. In this period Mars had much denser atmosphere and warmer climate, and it was the time when geochemical alteration happened and clays formed (Bibring et al. (2006)).

The Hesperian period is spanning from 3.74 Gyr to 2.9 Gyr ago and it is characterized by material northeast of the Hellas Planitia and it was the end of Heavy bombardment period. Large scale volcanism in lowland started. Fluid water is stored in permafrost. This period is also characteristic because of the sulfate deposits in the Vallis Marineris.

There are two different theories about when Amazonian period started. Hartmann's model states that the Amazonian period started at 2.9 Gyr and Neukum's chronology model states that it started at 3.31 Gyr. Characteristic of this period is extensive resurface process in northern lowland. Late stage vulcanism destroyed older units. In this period happened surface alteration and forming anhydrous ferric oxides that gave Mars characteristic red color (A. P. Rossi and S. Gasselt 2010).

2.3.2 Volcanism on Mars

The largest volcano province on Mars is Tharsis (P.K. Byrne 2020). It had high volcanic activity from peak activity in Noachian period until a few tens of million years ago (A. P. Rossi and S. Gasselt 2010). Difference from Earth's volcanism is mainly due to lower gravitational forces and atmospheric pressure. Because of that Mars has more extensive lava flows, areal distribution of volcanic deposits and diapirs (type of geological intrusion in a way that ductile material is forced into brittle overlying rocks) at lower depths. Size of volcanos is also linked to mantle plumes (mechanism of convection of abnormally hot rock within mantle, on Earth we can see it in Hawaii and Iceland) beneath them (A. P. Rossi and S. Gasselt 2010). Mars volcanos compared to Earth ones would classify as shield volcanos (A. Yin 2012). Area of Pavonis Mons is characterized by grabens, faults, lava tubes and small volcanic fields (D.E. Shean 2005). From observation of surface changes of wrinkle ridges and extensional structures can be concluded that Mars had tectonic movements in past. Tectonic activity was strongly connected to its volcanic past (A. P. Rossi and S. Gasselt 2010). Figure 4 shows volcanic landforms Olympus Mons, Highland Pateras near Hellas Basin, Tholus on Mars, lava flow near Arsia Mons and Pit chains. Figure 5 shows global tectonism and volcanism on Mars, A and B shows volcanic terrains, C and D compressional and extensional structures.

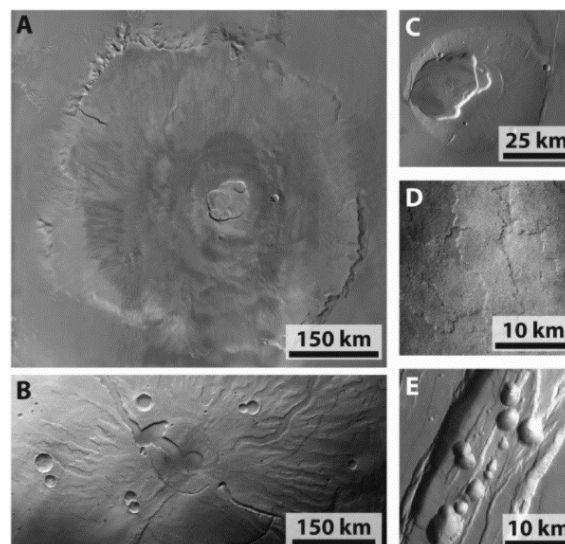

Figure 4 Volcanic landforms: A Olympus Mons (MEX HRSC nadir mosaic, courtesy A. Dumke), B Highland Pateras near Hellas Basin (MEX HRSC nadir from orbit 1920), C Tholus on Mars (MEX HRSC nadir from orbit 2983), D lava flow near Arsia Mons (MRO CTX P17 007484 1657

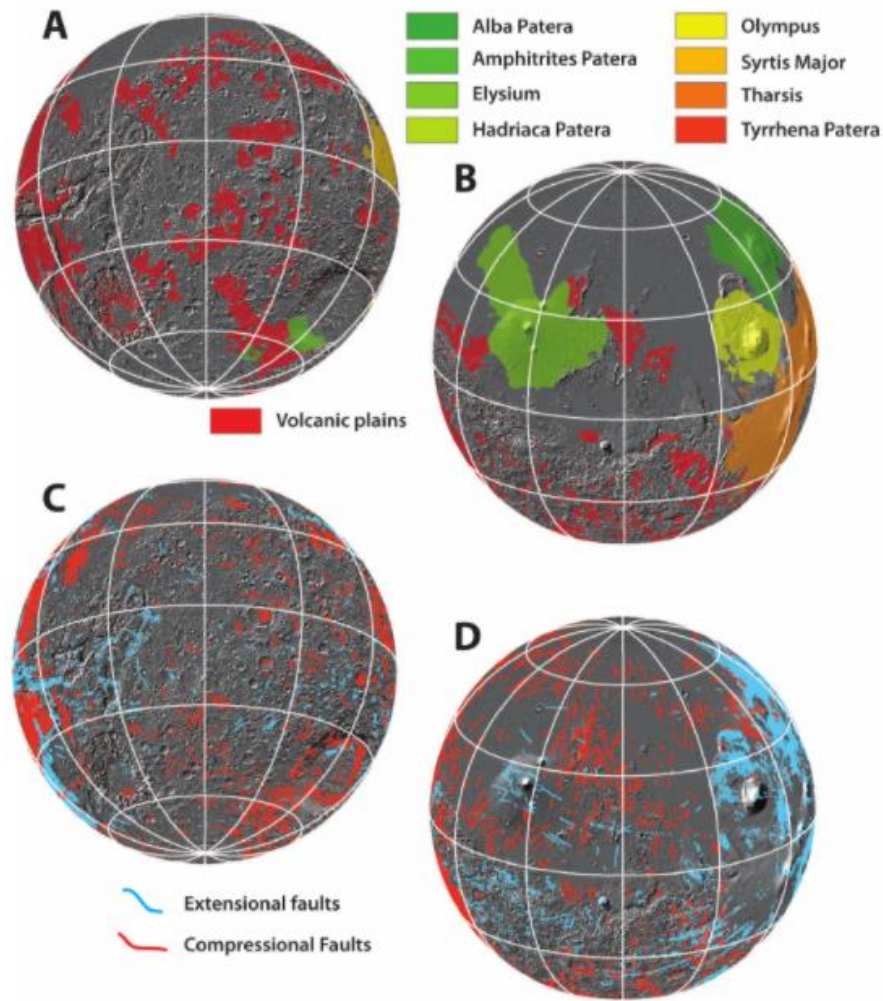

Figure 5 Global tectonism and volcanism on Mars, A and B shows volcanic terrains (data from Scott and Tanaka 1986), C and D compressional and extensional structures (data from Knapmeyer et al. 2006).

2.3.3 Rocks and sediments on Mars

The meteorites from Mars are all igneous rocks, low in silicon and high in iron and magnesium referred to as basalts. They are most common on Earth and also found on surface of the Moon (NASA).

On 4. December 2000 NASA's space probe Mars Global Surveyor took a significant photograph showing layers of sedimentary rock that once on ancient Mars contained water surface. Dr. M. Malin said " We see distinct, thick layers of rock within craters and other depressions for which a number of lines of evidence indicate that they may have formed in lakes or shallow seas. We have never before had this type of irrefutable evidence that sedimentary rocks are widespread on Mars." That evidence was found in western Candor Chasma in Valles Marinaris canyon (NASA).

Rover Curiosity found a variety of rock types and sediments on Mars. In 2012 it found Shale inside of the Gale crater. It was fine-grained and layered looked like it is easily breakable, on Earth rocks that break this way are usually made from clay minerals. That same year it found rock similar to Earth’s conglomerate. In 2015 Curiosity found sedimentary rocks in Gale Crater it contains deposits of fine laminated mudstone and on 27. August 2015, it found sandstone on the Mars’ Mount Sharp (Rampe et al. 2020).

2.3.3.1 Basalt

Basalt is igneous rock, has a dark color and it is fine grained, it forms from rapidly cooled low-viscosity lava that is rich in magnesium and iron. Dark color comes from plagioclase and pyroxene minerals (D.W. Hyndman 1985). Average density of basalt is 2.9 g/cm³ (A.R. Philpotts and J.J. Ague 2011). It can contain small cavities that are formed when gass bubble is dissolving and lava solidifies before it approaches surface (H. Blatt and R.J. Tracy 2001). Basalt is found through the solar system, and it is also common on Mars (J.P. Grotzinger 2013). It is most common volcanic rock on Earth.

2.3.3.2 Meteorites from Mars

Meteorites from Mars can give useful information about mineralogy of materials, since there is still no option to bring the samples back to Earth. In the late 1970 McSween et al. 1979, Walker et al. 1979, Wasson and Wetherill 1979, Bogard and Johnson 1983 differentiated first meteorites from Mars, they matched several geochemical-isotopic fingerprints between those that were made by the Viking missions and SNCs. First collected meteorite from Mars was Chassigny meteorite, it fell on Earth surface on October 3, 1815, also some samples were collected in Antarctica between 1977 and 1994. They were all magmatic in origin including basalts, Iherzolites, orthopyroxenite, clinopyroxenites – wehrlite and dunnite. Igneous minerals are usually basaltic shergottites, also dominant minerals are clinopyroxenes, pigeonite and augite. Minerals on mars can also be observed with the help of telescopes and spacecrafts, observed spectra can be assigned to the specific minerals or mineral groups. Viking lander analyzed chemical composition and magnetic properties of the Martian soil, it used imagery and reflection spectra. At this point Martian surface was categorized in terms of three spectral units: low-albedo, Fe²⁺ rich regions, high-albedo Fe³⁺ rich regions and intermediate albedo regions (Mineralogy society of America, J. J. Papike, editor 1998). Soil investigation showed that it contains much iron oxide, and also nanophase hematite and minor crystalline hematite (Morris et al. 1989, 1993).

Table 1 Analysis of Meteorite from Mars (R. Verish 2000)

Location	Los Angeles, California, USA (original find location unknown)
Time of recognition	1999 October 30
Type of the rock	Martian basalt (shergottite)

Description

Two stones, weighing 452.6 g and 245.4 g respectively, were found by Bob Verish in his back yard while he was cleaning out a box of rocks that was part of his rock collection. The specimens may have been collected ~20 years ago in the Mojave Desert. Classification and mineralogy (A. Rubin, P. Warren and J. Greenwood, UCLA): a basalt with a texture closely resembling that of the QUE 94201; plagioclase laths, 43.6 vol%, An₄₁Or₄ to An₅₈Or₁, have been shocked to maskelynite; Ca-pyroxene, 37.7 vol%, ranges from Fs₄₅Wo₁₃ to Fs₄₅Wo₃₇ to Fs₇₂Wo₂₄; other mineral modes, 4.9 vol% silica, 4.2 vol% fayalite, 2.4 vol% K-rich felsic glass, 3.5 vol% titanomagnetite, 2.7 vol% Ca phosphate (including whitlockite and chlorapatite), 0.7 vol% pyrrhotite, and 0.2 vol% ilmenite; contains a higher proportion of plagioclase than Shergotty or Zagami, and has pyroxene that is moderately more ferroan than that in QUE 94201. Specimens: main masses with finder; 30 g, UCLA (R. Verish 2000).

Photograph



2.3.3.3 Clay minerals

Clay minerals are hydrous minerals. That is important for understanding of geological evolution of Martian surface. For detection of clay on Mars rovers equipped with near-infrared reflectance spectroscopy are used, and like that many minerals on Martian surface have been discovered like hydrated silica, phyllosilicates, carbonates, sulfates, oxides and hydroxides (J.L. Bishop et al. 2008). Many clay minerals have been identified but their origins and formation mechanisms have not been resolved, and for that we need more detailed on-site investigations. For better understanding of clay on Mars we are investigating clays on Earth. (Y. Zhang et al. 2021) investigated clay coatings collected in Qaidam Basin and they concluded that various types of rock coatings with small amounts of clay minerals may occur in western region of Qaidam Basin. They chose that place because it has some similar conditions like on Mars; extremely arid and cold climate. All evidence found so far lead to believe that chemical weathering on Mars was less aggressive than on Earth and therefore

many coatings may be preserved (R.V. Morris et al. 2006). Noachian terrain contains Fe/Mg smectite and chlorite in coexistence with opaline silica (B.L. Ehlmann et al. 2009).

2.4 Climate and environmental conditions

Martian conditions are too harsh for humans to survive without life support system, since we are not able to breathe on Mars, and it does not have liquid water. Mars is a cold planet; average temperature is around -26.7°C . Mars has wind, clouds and occasional dust storms that range from small tornados to large storms that cover the whole planet, shown in figure 6.

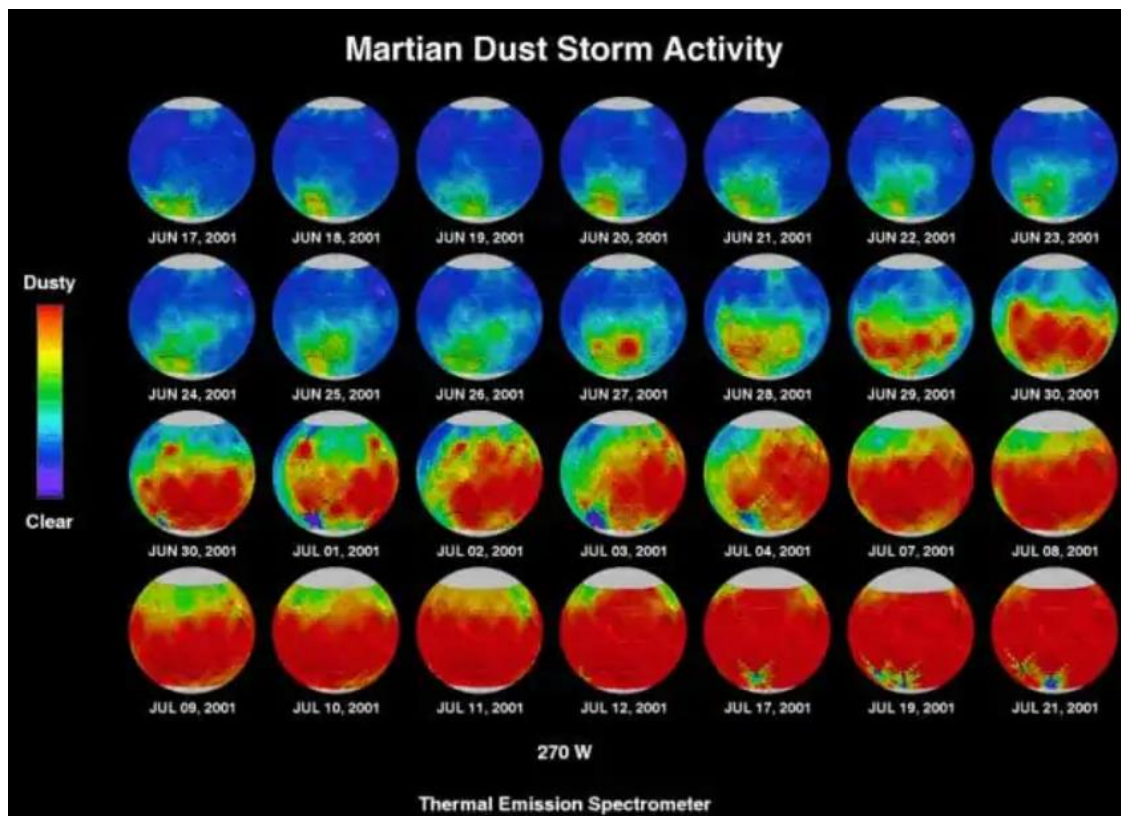

Figure 6 Martian Dust storm Activity (NASA 2001)

Martian atmosphere is thinner than Earth's, it contains 95% carbon dioxide and less than 1% oxygen. Mars is rotating slower than earth and has little longer days, 24.6 hours and a year on Mars is 687 days counted in Earth time (NASA 2020). The planetary axis is tilted about 25 degrees, similar to Earth, but the orbit is more elliptical so it has longer seasons. There is no rain, although snow is possible in high altitudes. NASA Mars Reconnaissance Orbiter detected snow in September 2012., near the south pole, it was made of carbon dioxide. Figure 7 shows the cyclone on Mars (NASA 2012). Table 2 shows comparison of Martian and Terrestrial conditions

Table 2 Martian and Terrestrial conditions

	Earth	Mars
Gravity	9.807 m/s ²	3.721 m/s ²
Average surface pressure	101325 Pa	610 Pa
Minimum temperature	-89.2 °C	-153 °C
Maximum temperature	56.7 °C	20 °C
Water condition	liquid	vapor
Atmosphere density	1.2 kg/m ³	0.25 kg/m ³

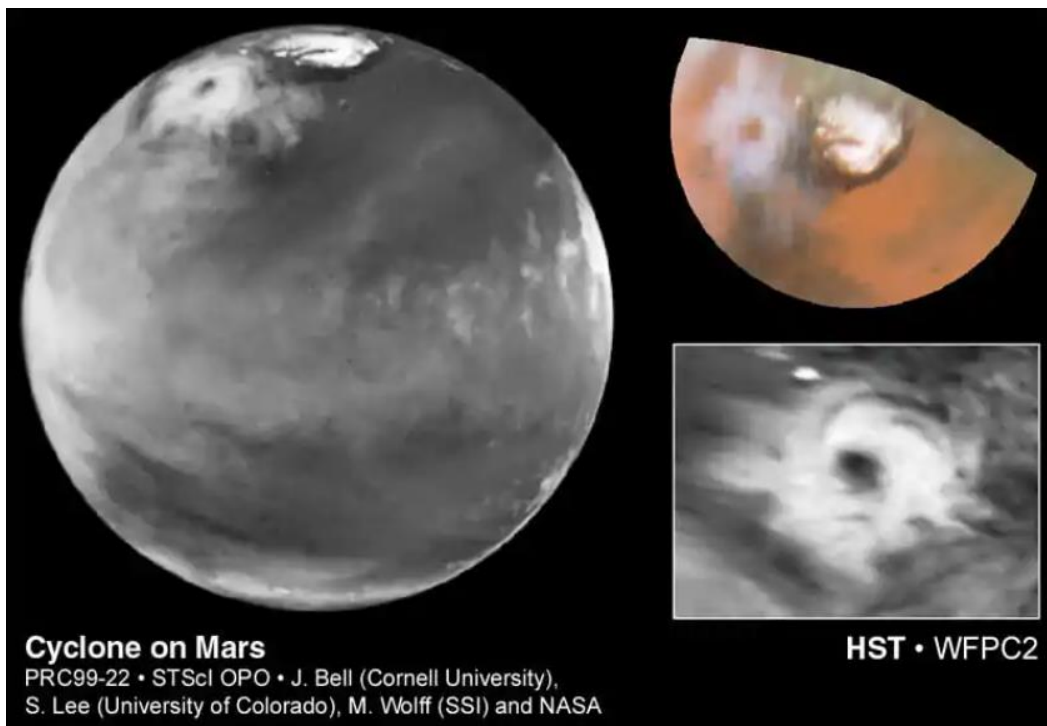

Figure 7 Cyclone on Mars (NASA 2012)

2.5 Site investigation of Mars and Moon

Investigation on Mars is still not possible to be human operated on-site because there is no way back yet. There are other ways to investigate Martian surface remotely like photogrammetry, it can be done from the satellites and rovers. Rovers are equipped with tools that enable them to make experiments and collect information. History of Moon exploration can be helpful in order to make better decisions for Martian exploration, there are some useful information in Apollo missions that are worth investigating.

Analog Mars missions are simulations of Martian conditions on Earth and they are providing with insight into real problems that might occur on Mars. AMADEE is analog Mars simulation organized and coordinated by Austrian space forum. They include Engineering, Geology and Biology investigations.

2.5.1 Structure from motion Photogrammetry

This method is fast and efficient way to make 3D mesh of any geological outcrop. This method relies on connecting multiple images of the same outcrop based on point location system with minimum overlapping. In recent times computer power is growing so much that processing huge number of pictures is relatively easy task. Result of this method is 3D mesh that is used to virtually reconstruct geological features from millimeter scale to kilometer scale outcrops. This method is helpful in situations of hardly accessible areas, caves and dangerous environments of other planets. In environment of other planets like Mars we rely on rovers monitored and guided from Earth. Figure 8 shows how virtual 3D model is created from pictures, there are points with the specific location that computer uses to overlap images and create the full model (G. Caravaca et al. 2020).

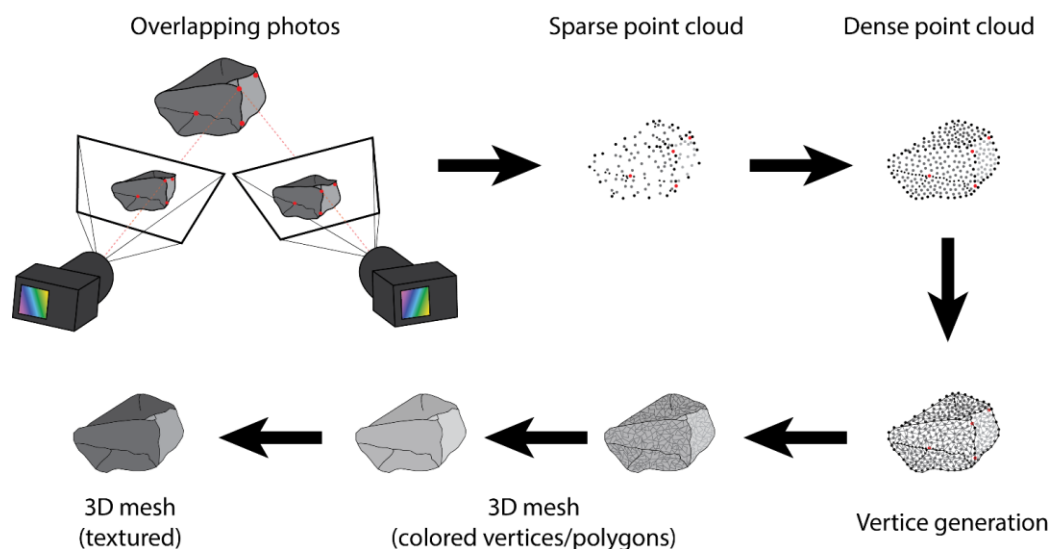

Figure 8 Process of photogrammetry from taking overlapping photographs to the 3D mesh structure with the help of point cloud (Caravaca et al. 2020).

(G. Caravaca et al. 2020) focused on reconstruction of the Kimberly outcrop analyzed by rover Curiosity in the Gale crater. They used images from Curiosity for constructing accurate multi-scale DOM and then integrated in within VR environment to virtually access this simulated in situ conditions that are in reality millions of kilometers away.

2.5.2 Missions to Moon; Apollo 12, Apollo 16 and Apollo 17

The Apollo program had six missions to the Moon between 1969 and 1972. Apollo astronauts deployed several experiment packages during missions. Data from instruments were telemetered to Earth after the astronauts left the moon. Apollo 12 was launched on 14. of November 1969 on a rocket Saturn V, for the purpose of exploring Moon. Instruments that Apollo 12 had:

- Passive Seismometer, for measuring seismic activity and physical properties of the lunar crust and interior;
- Lunar Surface Magnetometer, for measuring the magnetic field at the ALSEP site;
- Solar Wind Spectrometer, for measuring protons and electrons from the solar wind and magnetotail plasma impinging on the lunar surface;
- Suprathermal Ion Detector, for measuring positive ions reaching the lunar surface to provide data on the plasma interaction between the solar wind and the Moon;
- Cold Cathode Ion Gage, for measuring the density of neutral particles in the tenuous lunar atmosphere;
- Lunar Dust Detector, designed to assess the long-term effects of the lunar dust, radiation, and thermal environment on solar cells (NASA 1969-1672).

Apollo 16 mission was launched 16. Of April 1972, also on a rocket Saturn V. Primary mission objective was to carry out a geological survey and sampling and photo documentation in the Descartes region, also to conduct surface and to conduct lunar orbit experiments. The Apollo 16 astronauts have done many tests on lunar surface along with the geological studies, sample collection and surface photography. They collected samples of solar wind, with Cosmic ray detector, recorded heavy cosmic rays from solar, stellar, and galactic sources, with Portable surface Magnetometer they studied strength of local magnetic sources, using surface penetrometer they conducted soil mechanic investigations and studied lunar regolith. Other experiments were included in Apollo Lunar Surface Experiment Package (ALSEP). The Apollo 16 ALSEP instruments consisted of:

- A passive seismometer, for measuring seismic activity and physical properties of the lunar crust and interior
- An active seismic experiment to study the physical properties of lunar surface and subsurface materials and the structure of the local near-surface layers
- A Lunar surface magnetometer (LSM), designed to measure the magnetic field at the lunar surface
- A heat flow experiment, designed to measure the rate of heat loss from the lunar interior and the thermal properties of lunar material

The central station, located at coordinates 8.9754 S latitude, 15.4981 E longitude, was turned on at 19:38 UT on 21 April 1972 and had to be shut down along with the other ALSEP stations on 30 September 1977 (NASA 1969-1672).

Apollo 17 mission was the only mission (in Apollo missions) that had trained geologist on board (Harrison Schmitt), with that he was the first NASA scientist-astronaut in space. Apollo 17 was also the last mission of Apollo program. Launched on 07. December 1972, it included three days on Moon and usage of Lunar Roving Vehicle (LRV).

Main goal of this mission was to collect samples of lunar material and investigate volcanic activity. The Apollo 17 mission ALSEP instruments consisted of:

- A lunar ejecta and meteorites experiment, for measuring the frequency with which the moon was impacted by primary cosmic dust particles and lunar ejecta
- A lunar atmospheric composition experiment, designed to study the composition and variations in the lunar atmosphere
- A lunar surface gravimeter, for obtaining highly accurate measurements of the lunar gravity and its temporal variations at a specific point on the surface
- A heat flow experiment, for measuring the rate of heat loss from the lunar interior and the thermal properties of lunar material
- A lunar seismic profiling experiment, for acquiring data on the physical properties of the lunar near-surface materials and for monitoring natural seismic activities (NASA 1969-1972).

2.5.3 Robots on Mars- equipment

The goal of most Mars exploration programs is to understand the historical conditions of the Martian surface, how they helped create the surface existing today and to find proof of life. Because of that, humans started sending rovers to Mars, since it is still one-way trip, humans are not yet ready to go, but rovers on Mars can be operated from Earth. Rovers are equipped with some tools and machines like laboratories on Earth. The first operating rover on the surface of Mars was Sojourner on 04. July 1997, delivered with U.S. spacecraft "Mars Pathfinder" that rover was "proof of concept" for technologies of that time, such as airbag landing system and automated avoidance of obstacles (see figure 9) (NASA). After that NASA landed 4 more rovers on Mars Spirit (landed on 04. January 2004), Opportunity (landed on 25. January 2004), Curiosity (landed on 06. August 2012), and Perseverance with Ingenuity (landed on 18. February 2021).

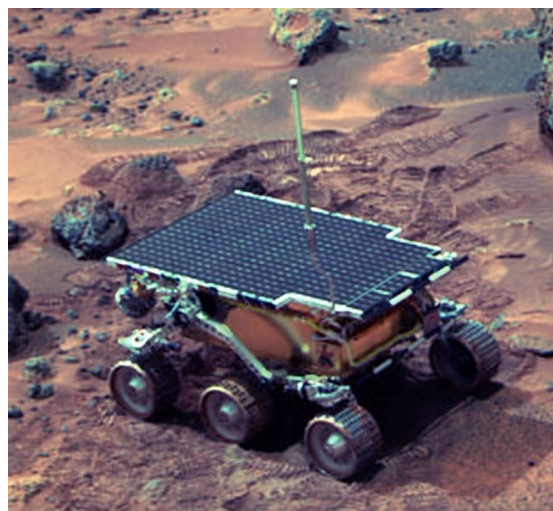

Figure 9 PIA01122: Sojourner Rover Near "The Dice" (NASA)

2.5.3.1 Rover Curiosity

NASA's Mars Science Laboratory mission rover Curiosity launched from Earth on November 26, 2011 and landed on Mars at 10:32 p.m. PDT on Aug. 5, 2012 (1:32 a.m. EDT on Aug. 6, 2012). Curiosity was sent to answer the question: Did Mars ever have the right environmental conditions to support small life forms called extant paleomicrobiology? Curiosity found chemical and mineral evidence of past habitable environments on Mars. Today it still continues to explore Gale crater and acquires new samples for onboard analysis. He is carrying 10 instruments and 17 cameras (NASA).

Figure 10 shows most recent path of Curiosity rover on sol 3117 on Mars.

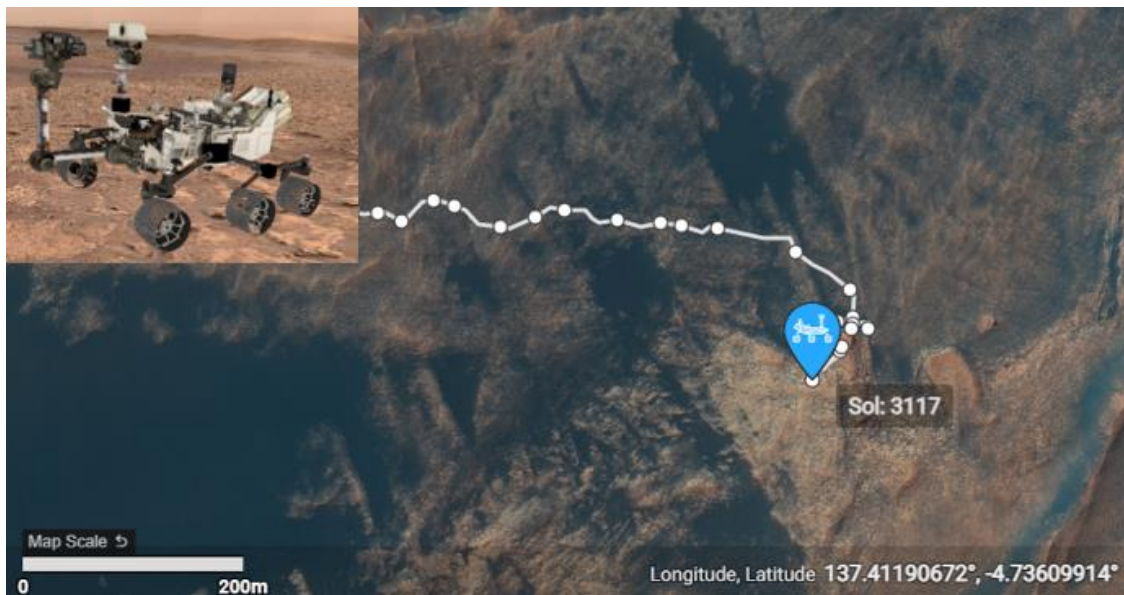

Figure 10 Part of the path that Curiosity passed until sol 3117 (NASA)

Sample processing, handling and acquisition of the original concept of rover consisted of two robotic arms and equipment. Heavy rattling equipment for drilling and acquiring rock cores on one hand and the fine task analysis and soil scooping activities on other one. Sample processing system was designed to have two rock crushers for smashing and sieving rock samples, a sample delivery system to move these samples to the analytical laboratory instruments and at the end detritus ejection system.

Remote sensing instruments: Mars Descent Imager (MARDI) located on the body of rover used for high-resolution color-video imagery of the descent and landing phase that provides geological context information and precise landing determination, Mast Camera (Mastcam), located on the mast, for performing multi-spectral stereo imaging and videos at ten frames per second without using the rover computer, ChemCam is laser induced Remote sensing for Chemistry and Micro-Imaging and it is also located on mast, for measuring elemental composition of underlying rocks and soils. Figure 11 shows different instrument placement on rover Curiosity (E. Lakdawalla 2018a).

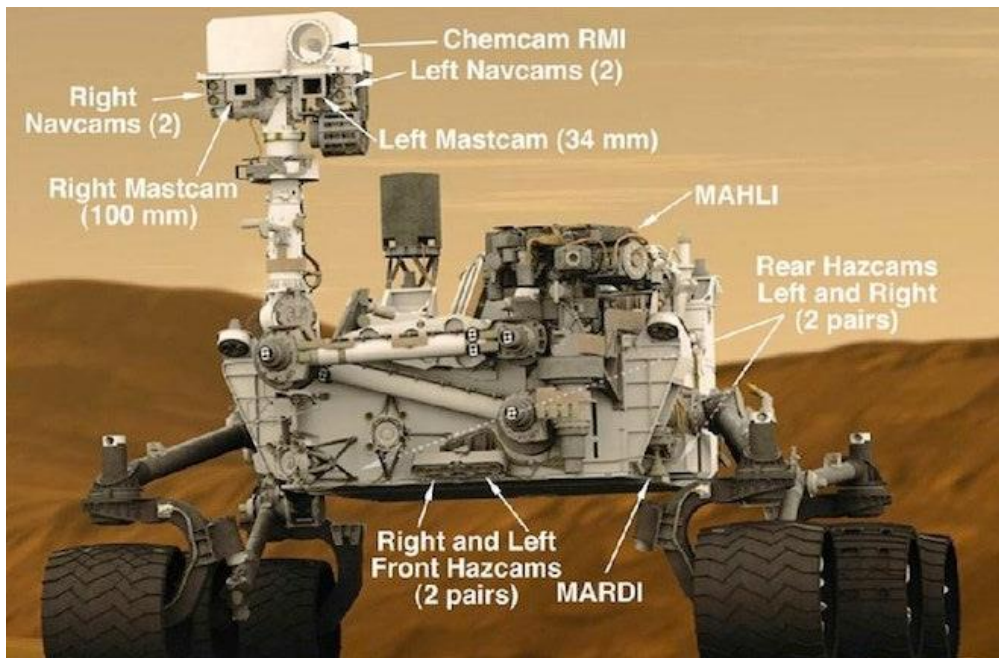

Figure 11 Rover Curiosity (NASA)

In-situ instruments: Mars Hand Lens Imager (MAHLI) is located on arm turret, used for image of rocks, soil, frost and ice at better resolutions and wider field of view. Alpha Particle X-ray Spectrometer (APXS) is located on the arm turret, used for determining elemental abundance of rock and soil. Radiation Assessment Detector (RAD) is located on the body of rover, used for characterization of the broad spectrum of radiation at the surface of Mars. Dynamic Analysis of Neutrons (DAN) is located on the body of rover, used for analysis of the hydrogen content of the subsurface. Rover Environmental Monitoring Station (REMS) is on more locations of the rover, and it is used for measuring temperature, pressure, wind direction and speed, humidity, UV dose, atmospheric dust and local fluctuations in magnetic field. Figure 12 shows sample sites on Mars, each is MAHLI focus stack taken from exactly 5 centimeters standoff distance (E. Lakdawalla 2018a).

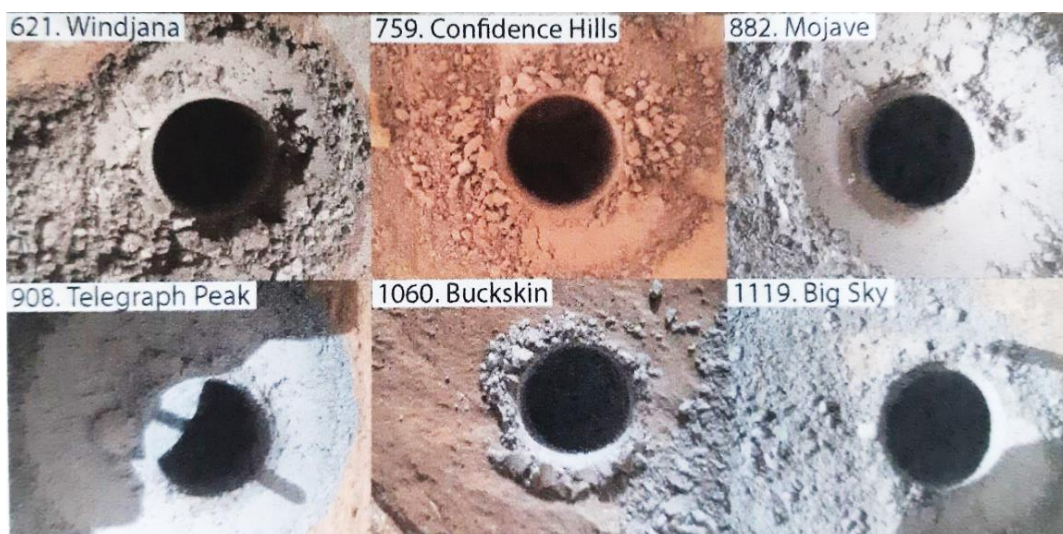

Figure 12 Small boreholes made by Mars rover (E. Lakdawalla 2018a)

Laboratory instruments: CheMin is located on the body of rover and it is an X-ray Diffraction/X-ray Fluorescence (XRD/XRF) instrument for identification and quantification of the minerals in samples of basalts, evaporites and soils. Sample Analysis on Mars (SAM) is located on the body of rover, it consists of gas chromatograph mass spectrometer and tunable laser spectrometer, it can perform mineral and atmospheric analyses, also detect much wider range of organic compounds and perform stable analysis of organics and gasses (E. Lakdawalla 2018b).

Rover is using 4.8 kilograms of plutonium dioxide as the source of power and heat it produces around 100 watts and has 2 lithium ion rechargeable batteries (NASA).

2.5.3.2 Rover Perseverance with small helicopter Ingenuity

The MSL Perseverance rover landed on Mars on 18. February 2021 as a part of the Mars 2020 Exploration mission. The main goal of this mission is long-term effort of robotic exploration of Mars, also looking for the signs of life is crucial (NASA). Perseverance rover is investigating region of Mars Jezero crater and look for potential signs of life by collecting rock and samples and prepare them for a future return to Earth (NASA). The rover has a new subsystem for collecting and preparing samples that includes a coring drill on its arm and sample tubes, it is planned that up to 30 of those tubes will be collected and returned to Earth in a sample-retrieval mission where they will be analyzed more detailed. It is important to extensively explore all possibilities of microbial life before sending humans because of possible health hazards for future missions. It also has two instruments for high-resolution imaging and three types of devices for spectroscopy for characterization of rock and soil.

Instruments as shown on figure 13:

- Mastcam-Z
- SuperCam
- Planetary Instrument for X-RAY Lithochemistry (PIXL)
- Scanning Habitable Environments with Raman & Luminescence for Organics and Chemicals (SHERLOC)
- Mars Oxygen In-Situ Resource Utilization Experiment (MOXIE)
- Mars Environmental Dynamics Analyzer (MEDA)
- Radar Imager for Mars' Subsurface Experiment (RIMFAX)

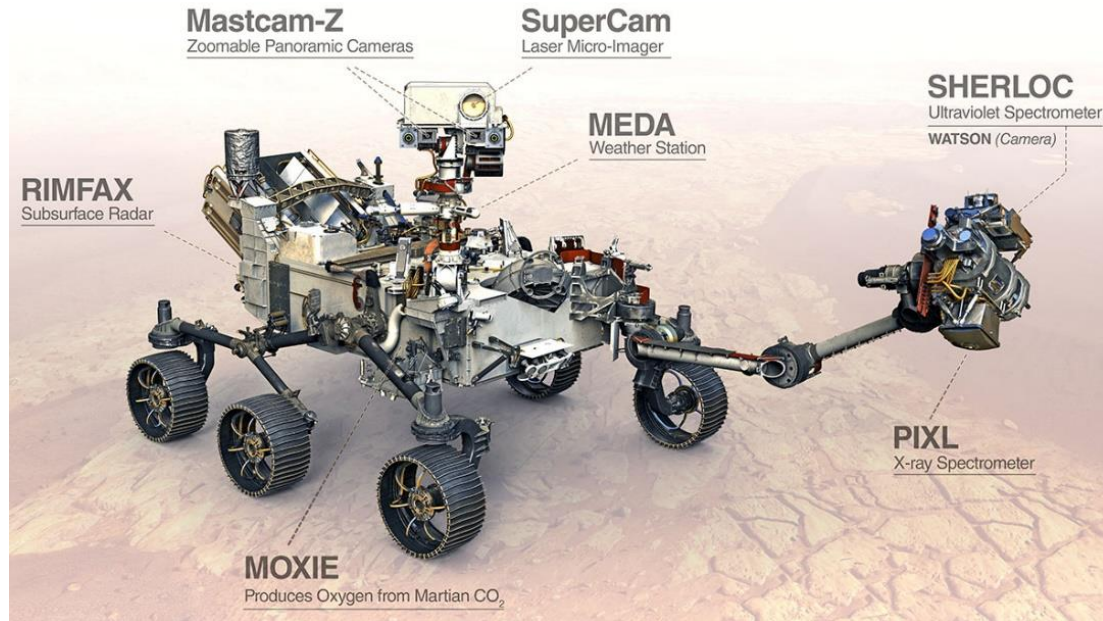

Figure 13 Perseverance rover (NASA)

2.5.4 Tools used in AMADEE missions by ÖWF

ÖWF conducted a MARS2013 simulation in February 2013, it was a high-fidelity Mars analog mission in Morocco Sahara, 17 experiments were conducted. That site was chosen for its environmental conditions and terrain diversity for a wide range of robotic tests regarding trafficability and other telemetry tests (ÖWF). Moreover, its geological history is similar to Martian. In this mission next tools have been used:

- Visible wavelength imaging for target context
- an onboard rover RGB camera
- laser-induced fluorescence emission (L.I.F.E.) spectra elicited by excitation with 405 and 532 nm laser diodes.

Tools that are always present in tool box of the analog space suit:

- Adapted geological hammer (shortened smaller version compatible with the spacesuit chest pack),
- Bags for sample collection, size and color calibration bar, small hand-held mirror,
- Additional camera to the one that is already mounted on the suit helmet,
- Grabbing stick for the sample collection.

Additional tools used in previous missions:

- Ground penetrating radar
- Acoustic geophones, triggered by hammer
- Shallow (<30cm) drilling, human operated
- Power drill (challenge because of dust when drilling a hard rock)
- Schmitt hammer
- Laser fluorescence instruments (L.I.F.E.)

Equipment that is situated in the habitat:

- Microscope (with camera for transferring images to Earth),
- Magnet (ÖWF)

Tools used after mission to test collected samples:

- In-depth spectroscopic tools; Raman, LIBS etc.

AMADEE-15 mission was conducted in Kaunertal Glacier, Austria in August 2015, it lasted two weeks. Mission included many different fields of science, like engineering, astrobiology and geosciences. Analog astronauts conducted exploration with robotic vehicles and together with support team in Innsbruck they emulated real Martian exploration. Some of the experiments that were conducted:

- BCC (balloon carried camera)
- CLIFFBOT CRV (concept rover for accessing difficult terrains)
- Glacier-MASE (for sampling glacier materials and life detection)
- GPRoG (for collecting ground penetrating radar data)
- LICHEN (for measuring of lichen diameters and morain age dating via Schmidt hammer)
- L.I.F.E (Laser-induced Fluorescence Emission)
- Puli Rocks (for moving rocks on extreme terrains)
- WoRIS (for investigation of rate of cryoconite development and thermal conductivity of ice) (ÖWF)

AMADEE-18 mission was conducted in the Dhofar region, Oman in February 2018. Mission goal was to gain operational experience and to understand remote science operations on other planets. Some of the experiments that were conducted:

- A3DPT-2-Mars (3D printing for crewed Mars expeditions)
- AVI-NAV (drone vertical take-off and landing)
- EOS (radio navigation system for EVA's on planet without GPS)
- Field Spectrometry (reflectance and radiance spectra)
- Husky (autonomous rover for support and area mapping)
- ScanMars (Subsurface Characterization of a Martian Analogue through 2D/3D Ground Penetrating Radar datasets)
- V(R)ITAGO (Virtual Reality for astronaut training and for helping the remote science support team in analyzing geology) (ÖWF)

3. Site investigation on Earth

Site investigations on Earth are made before building any construction, so it can be done with appropriate tools for that specific location. It is the same on Mars but we have to add other environmental conditions in that choice of tools. Water on Mars is rare to find, and does not really exist in liquid form in lakes, rivers and seas like on Earth. That is one of the main limitations for tools and reasons those devices are excluded from this thesis, also there are many tools and machines for geotechnical investigations and they are not all included in this study.

Devices are chosen by criteria that they have to be as simple as possible, they should not use water in any way, size should be adjustable or relatively small, it needs to be plausible and they have to be transferable and possibly modified. Some of those tools are described more detailly in the sections: 3.1 Characterization of soils and 3.2 Characterization of Rocks.

Some of devices that are excluded from the beginning are shown in tables 3 and 4, main reason for excluding these devices is that they require liquid water for functioning or saturated samples, and since Mars doesn't have liquid water, and thus saturated samples, maybe these devices are not the best suited for testing in Martian conditions. Additionally, Triaxial device (table 4) require samples to be prepared and cut in specific shape when used to test rock samples and that could be difficult to do on Mars, there are many pieces that can easily break, like membrane and small pipes that are bringing water to the main chamber, requires long time for experiments to be done plus size, and for those reasons it is excluded from more detailed analysis here. There are many geotechnical tools and devices and they are not all taken into consideration, because of limited time for writing this thesis.

Table 3 Excluded devices for soil testing.

Device/test	Reason for excluding them
Atterberg limits	This test needs to be conducted with liquid water. Size of this device is relatively small, and if really needed on Mars and if conducted in laboratory and if liquid water wasn't so scarce and limited it could be adapted and used on Mars.
Oedometer test	Sample needs to be submerged in liquid water
Triaxial test	Requires fluid in the chamber
Water permeability tests	Requires liquid water
Proctor device	Requires liquid water

Table 4 Excluded devices for rock testing.

Device/test	Reason for excluding them
Swelling tests	Requires liquid water
Slake durability test	Requires liquid water
Triaxial test	Requires fluid in the chamber, samples need to be prepared and cut in specific shape

3.1 Characterization of soils

It is important to know of soil properties: Color because it can indicate mineral composition, granulometric composition, different sizes of particles have different characteristics and behavior, strength, soil resistance to penetration and pressure is important to determine before building structures. For knowing those properties proper tools have to be selected. In the next section few of those tools, machines and techniques are described, all of them can be used on site, but grain size analysis can also be conducted in laboratory.

3.1.1 Geotechnical description of soils

The purpose of geotechnical descriptive analysis of soils is to determine starting point for planning site investigations. To determine is soil mainly granular or cohesive, what is the color of the soil could indicate its mineralogical content, water saturation is also important factor. Investigation should be based on the sequence:

- differentiate soil by its particle distribution,
- corresponding color observed on site; yellow and red colors indicate presence of iron oxides, brown indicates organic materials...
- is soil structure homogenous (soil has uniform characteristics), stratified (different soil layers), banded (residual layers are present) or laminated (soil layers are less than 3mm thick)
- density and consistency (table 5 and table 6)
- record environment conditions and sample moisture conditions (was it in open container or in sealed one) (EN ISO 14688)

Table 5 Density and field description of granular soils (L.I. Gonzalez de Vallejo and M. Ferrer 2011)

Density	Relative density (%)	Field assessment
Loose	<35	Easily penetrated by hand held 12.5 mm diameter steel bar
Medium dense	35-65	Easily penetrated by steel bar with a hammer of 2-3kg
Dense	66-85	Easily penetrated to a depth of 30cm by a steel bar and hammer
Very dense	>85	Only penetrated a few cm by a steel bar and hammer

Table 6 Consistency and field description of cohesive soils in the field and guide to strength (L.I. Gonzalez de Vallejo and M. Ferrer 2011)

Consistency	Uniaxial compressive strength (MPa)	Field identity test
Very soft	0-0.025	Soil squeezes through the fingers when hand is closed

Soft	0.025-0.050	Easily molded with fingers
Firm	0.500-0.100	Molded with strong pressure from the fingers
Stiff	0.100-0.150	Dented with strong pressure from the fingers
Very stiff	0.150-0.200	Slightly dented with strong pressure from the fingers
Hard	>0.200	Slightly dented with a pencil

3.1.2. Grain size analysis

Granulometry is fundamental measurement of grain size distribution in soil sample and it has effect on engineering behavior of the soil. Moreover, it has wide applications in earth and archeological sciences. Size of the particles depends on environment, transport agent of the particle's duration and length of that transport and conditions of the deposit site. Generally, soil is divided in four categories regarding particle size: gravel, sand, silt and clay. Larger particles gravel and sand can be categorized by sieving them in set of sieves with different hole sizes, with larger ones on the top as shown in figure 14. Fines cannot be sieved since particles are so small that their weight is negligible compared to the force between particles, so other methods have to be used, all of them are based on sedimentation of the particles in water so they are not going to be explained in this paper.

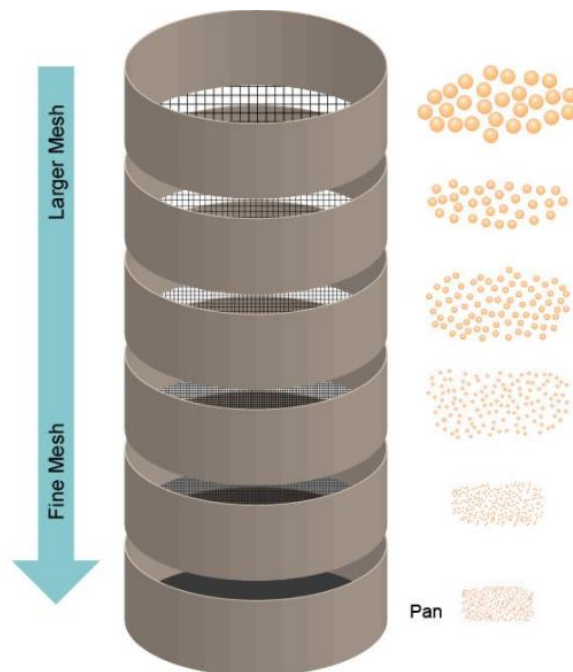

Figure 14 Sieves for grain size distribution (Particletechlabs)

Soil is variable material in particle size and chemical structure. First categorization of soil is by the particle size (table 7)

Table 7 Grain size ranges (EN ISO 14688)

Soil group	Particle size fractions (symbol)	Range of particle sizes mm
Very coarse soil	Large boulder (lBo)	>630
	Boulder (Bo)	>200 to ≤630
	Cobble (Co)	>63 to ≤200
Coarse soil	Gravel (Gr)	>2,0 to ≤63
	Coarse gravel (cGr)	>20 to ≤63
	Medium gravel (mGr)	>6,3 to ≤20
	Fine gravel (fGr)	>2,0 to ≤6,3
	Sand (Sa)	>0,063 to ≤2,0
	Coarse sand (cSa)	>0,63 to ≤2,0
	Medium sand (mSa)	>0,20 to ≤0,63
	Fine sand (fSa)	>0,063 to ≤0,20
Fine soil	Silt (Si)	>0,002 to ≤0,063
	Coarse silt (cSi)	>0,02 to ≤0,063
	Medium silt (mSi)	>0,006 3 to ≤0,02
	Fine silt (fSi)	>0,002 to ≤0,006 3
	Clay (Cl)	≤0,002

Result of the sieving method is particle size distribution graph, it can be used to calculate uniformity coefficient C_u and coefficient of curvature C_c .

$$C_u = \frac{D_{60}}{D_{10}} \quad C_c = \frac{D_{30}^2}{D_{60} \cdot D_{10}}$$

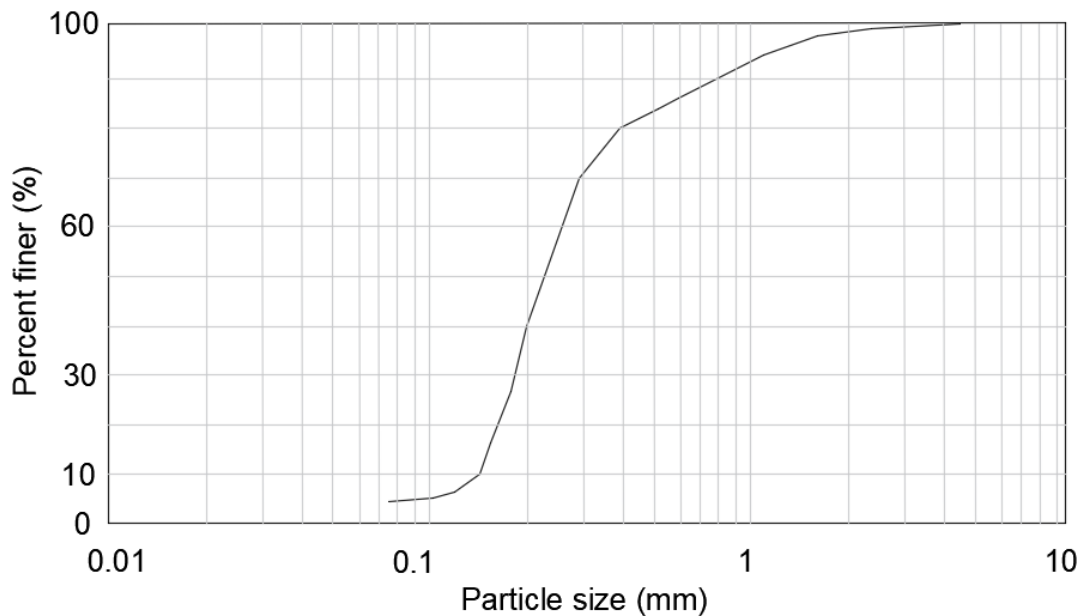

Figure 15 Particle size distribution of sand (adapted from (L.I. Gonzalez de Vallejo and M. Ferrer 2011)).

3.1.2 Standard penetration test

Standard penetration test is used to measure soil resistance to the dynamic penetration during boring and for obtaining disturbed soil samples. For this test mass of 63.5kg is dropped on the drill rod from the height of 760 mm and number of blows that takes for the rod to penetrate into the ground for 300 mm, more detailed description of this process is given in ASTM D 1586-67. Figure 16 shows setup for standard penetration test. This system can be automatic or manual. This test should be conducted in a borehole of 65-115 mm diameter. This test is simple and inexpensive, but the accuracy is highly dependent on procedure details. It should be mainly used for determining strength and compressibility index of sandy soils (R. Lancellotta 1995).

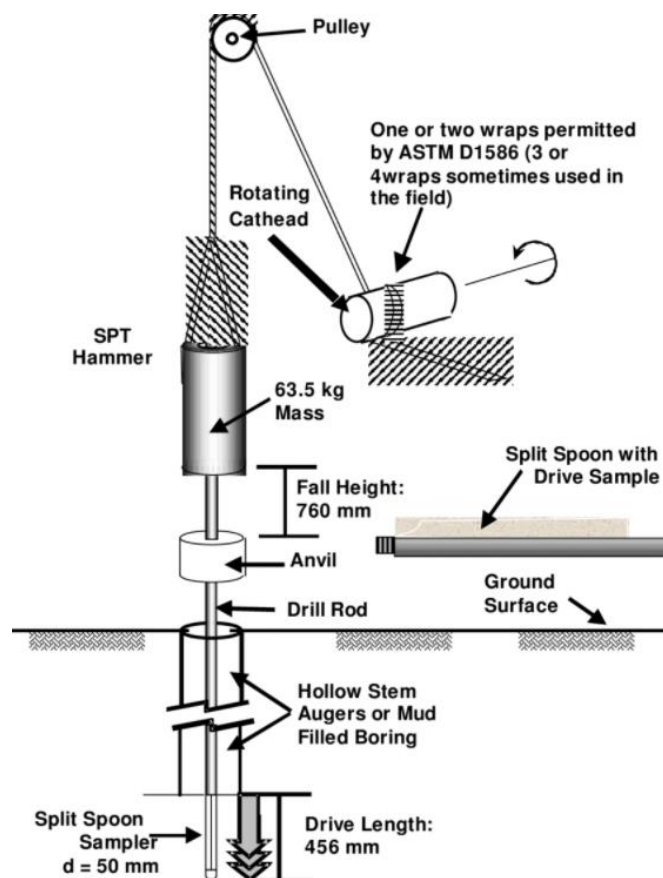

Figure 16 Setup and Equipment for the Standard Penetration Test (SPT) (adapted from Kovacs et al., 1981).

Correction factors to the measured number of blows is calculated with the following formula:

$$N_{60} = \frac{E_r}{60} * N$$

E_r = energy ratio

N_{60} = corrected value of blows

N = number of blows

The correction factor in sands is calculated differently because sands can exhibit different values at different depths even if the density index is the same, here Correction factor C_n is combined according to the consolidation of the sand (table 8) (I. Smith 2014).

$$N_{60,sand} = \frac{E_r * N * C_n}{60}$$

Table 8 Correction factor for overburden effective vertical stress, σ' (kPa) (I. Smith 2014).

Type of consolidation	Density index, I_D (%)	Correction factor, C_N
Normally consolidated	40-60	$\frac{200}{100 + \sigma_v'}$
	60-80	$\frac{300}{200 + \sigma_v'}$
Over consolidated	-	$\frac{170}{70 + \sigma_v'}$

Correction factors due to the length of the rod are calculated with the following formula:

$$N_{60} = \frac{E_r * N * C_n * \lambda}{60}$$

λ = correction factor due to the length of the rod (table 9)

Table 9 Correction factors due to the length of rod (I. Smith 2014).

Rod length (m)	Correction factor λ
>10	1.0
6-10	0.95
4-6	0.85
3-4	0.75

Energy of the hammer (J) = mass of the hammer (kg) * gravitational acceleration (m/s²) * height of the hammer free fall (0.76m)

Energy ratio (%) = Calibrated energy applied to the top of the rod / Energy of the hammer

Effective overburden pressure (kPa) = depth of the test * unit weight – ground water level * gravitational acceleration (m/s²)

Correlation between blow count and density index is developed by Terzaghi and Peck (1948) and later developed by Gibbs and Holtz (1957), more recent work adjusted that figures and normalized them (table 10) (I. Smith 2014).

Table 10 Correlation between normalized blow values and density index (I. Smith 2014).

State of density	N_{60}	Density index, I_D (%)
Very loose	0-3	0-15
Loose	3-8	15-35
Medium	8-25	35-65
Dense	25-42	65-85
Very dense	42-58	85-100

3.1.3 Static cone penetration

Static cone penetration test is used to determine and indicate measurements related to mechanical properties of the soil with continuously penetrating device. Resistance of the tip to the penetration is measured separately from the frictional resistance of the sleeve area, for this test cone is first pushed at a constant rate of 20mm/s until the retaining sleeve engages with the friction jacket and after that they are pushed together. Disadvantage of this test is that is slow and not so accurate in soft soils (R. Lancellotta 1995). Electrical version of this device has tip and friction sleeve of the same diameter and the end resistance is measured by the load cells. Advantage of this system is repeatability accurate results continuous recording and possibility of adding more sensors to it. This device is used for offshore investigations (R. Lancellotta 1995). Figure 17 shows schematic of the static cone penetrometer and how it works when connected to the vehicle. Figure 18 shows Cone resistance (q_c) and angle of internal friction (ϕ) for non-cemented sands (P.K. Robertson and R.G. Campanela 1983). Figure 19 shows graph of vertical effective pressure and q_c changes with different angles.

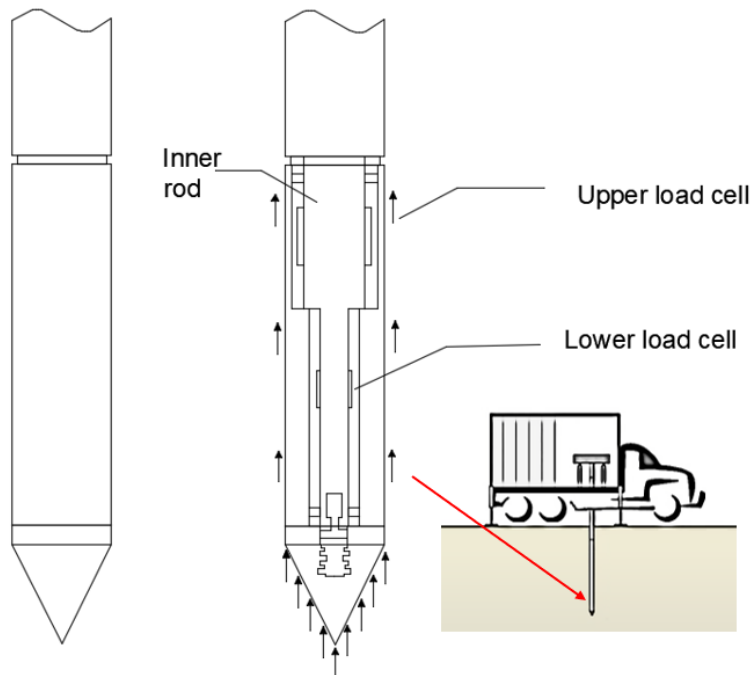

Figure 17 Schematic drawing of the instrumented cone penetrometer (adapted from (R. Lancellotta 1995)).

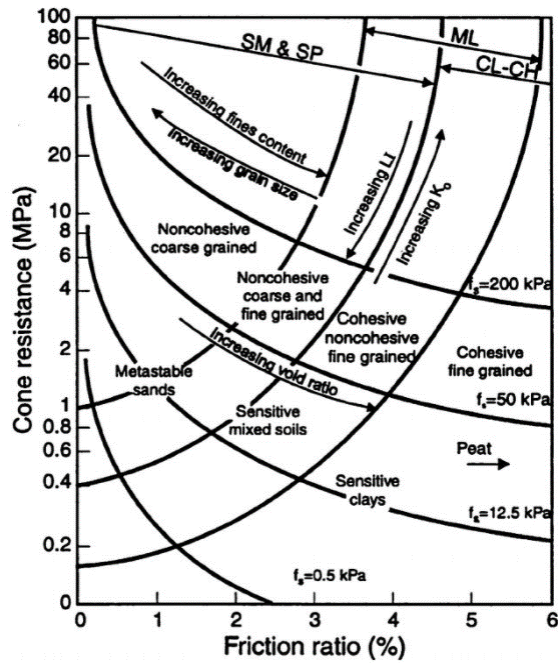

Figure 18 Cone resistance (q_c) and angle of internal friction (ϕ) for non-cemented sands (P.K. Robertson and R.G. Campanella 1983).

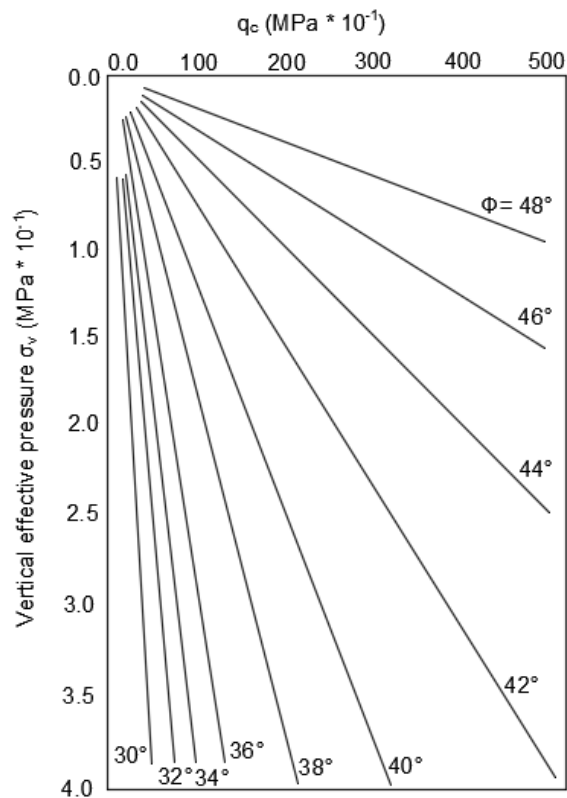

Figure 19 Vertical effective pressure and q_c changes with different angles (P.K. Robertson and R.G. Campanella 1983).

3.1.4 Field Vane test

Field Vane test is used for determining onsite undrained strength of soft clays. It provides measurements on intervals of 0.5m and it is more economical than standard laboratory tests. Device consists of four blades with the H/D ratio of 2, as shown on figure 20. Most commonly used dimensions are 130mm/65mm, and sometimes if used in soft clays it can be bigger. Test is conducted by rotating four blades and measuring maximum torque needed for blade rotation. After inserting the blades into the soil, it is appropriate to wait 5 minutes before conducting the test (R. Lancellotta 1995). This test is more detailedly described in ASTM D-2573.

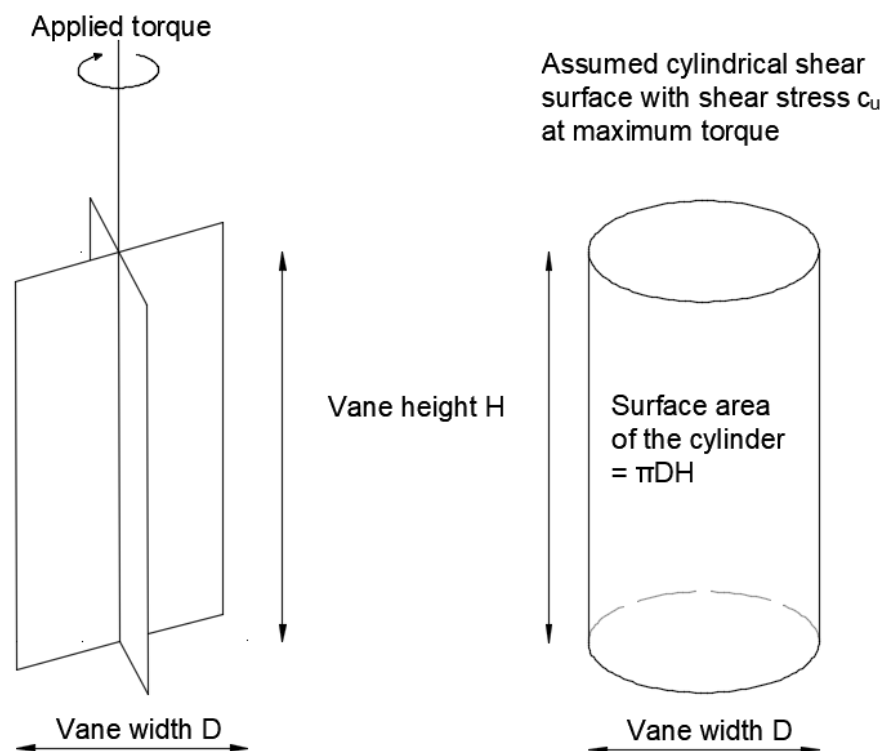

Figure 20 Schematic of the blade, Field Vane test and surface area of the shear stress.

Calculation undrained shear strength of the soil is possible with the following formula:

$$T = c_u * \frac{\pi * D^2 * H}{2} * \left(1 + \frac{D}{3H}\right)$$

C_u = undrained shear strength of the soil

T = applied torque that is the same as moment of the resistance of the of the vane blades

D = measured width of the vane

H = measured height of the vane

3.1.5 Pressuremeter test

Menard pressuremeter test is used for measuring membrane volumetric expansion and pressure of the borehole. This device has cylindrical probe that contains inflatable membrane shown in figure 22, the probe is lowered to the borehole and membrane is expanded under pressure. Test results can be used to derive strength and deformation parameters of the ground, like pressuremeter modulus and limit pressure that can be used to determine bearing resistance and the settlement of the spread foundations. Aside from this device developed in 1950 there are newer versions that include self-boring possibility and full displacement parameters (I. Smith 2014). Depending on type of soil we can identify pressure-deformation curve that starts when probe enters into contact with the sides of the borehole; initial phase, elastic behavior and plastic behavior up to soil failure at the end as shown in figure 21. From this curve we can calculate pressiometric deformation modulus with the following formula (L.I. Gonzalez de Vallejo and M. Ferrer 2011);

$$E_p = (1 + \nu)M * r$$

ν = Poisson's ratio

M = stiffness of the ground calculated from the slope of elastic section of the pressiometric curve

r = radius of the borehole (L.I. Gonzalez de Vallejo and M. Ferrer 2011)

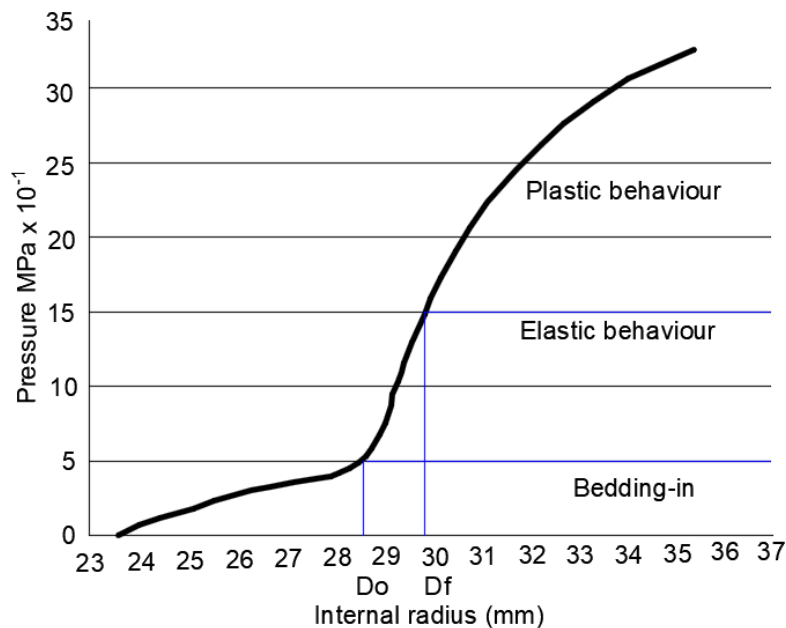

Figure 21 Graph Pressure/ internal radius;initial phase, elastic behavior and plastic behavior up to soil failure at the end (adapted from (L.I. Gonzalez de Vallejo and M. Ferrer 2011)).

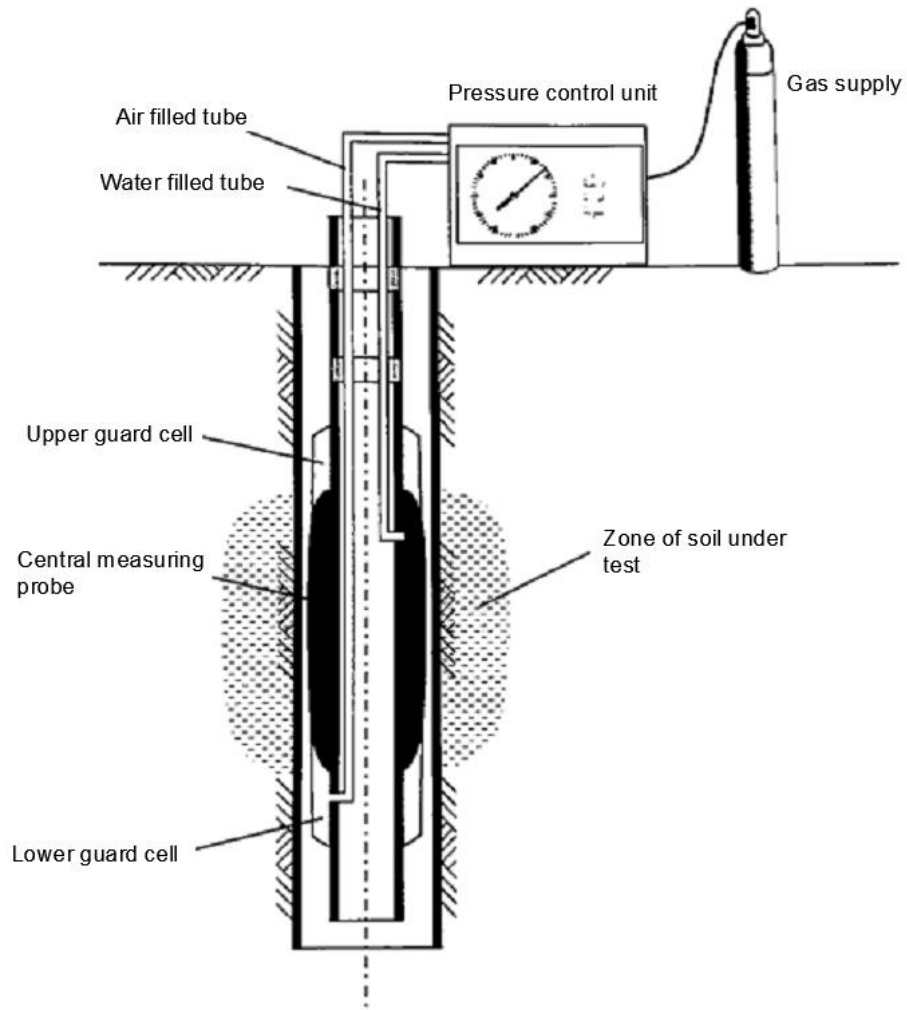

Figure 22 Device for pressuremeter test (I. Smith 2014).

3.2 Characterization of rocks

It is important to know rock properties, some of them are strength, elasticity, point load strength, strength of discontinuities, angle friction, P-wave velocity, abrasivity and hardness. Those properties are helping with later choice of machinery and tools that need to be used for certain actions done in rock material, like excavations, determining stability, and other. In the next section few of those tools, machines and techniques are described. These specific tools are chosen because they don't use water and they are relatively simple and easy to use. Current standards on rock characterization are (EN ISO 14689).

3.2.1 Tests conducted in laboratory and on-site

3.2.1.1 Schmidt hammer test

Schmidt hammer or also known as Swiss hammer or rebound hammer is a device that is used to determine strength and elastic properties of rock, surface hardness and penetration resistance (figure 23). This hammer is measuring rebound of the spring-loaded mass on surface impact. When conducting this test hammer needs to be held at right angles compared to the surface of the sample because rebound is affected by hammers orientation, also surface of the sample should be smooth and flat. This device is affected by gravity forces and it needs to be calibrated before usage. At least twelve readings should be taken, highest and lowest reading should be excluded. This device gives results according to the surface properties and it is suitable for sample comparison. Advantages of this device are it is easy to use, it is small, low cost, not affected by temperature change (EN ISO 14689). AMADEE-15 Mars Mission Simulation proved that can be performed under simulated Martian conditions. Table 11 shows Correlation between Schmidt hammer rebound and uniaxial compressive strength and Young's modulus (S. Saptonoa, S. Kramadibrata, B. Sulistianto 2013).

Table 11 Correlation between Schmidt hammer rebound and uniaxial compressive strength and Young's modulus (S. Saptonoa, S. Kramadibrata, B. Sulistianto 2013).

Equation	R ²	Researcher	Lithology
UCS			
$UCS = 6.9 \times 10^{(0.0087R + 0.16)}$	0.94	Deere and Miller (1966)	varied
$UCS = 6.9 \times 10^{(1.348\gamma R - 1.325)}$	-	Aufmuth (1973)	varied
$UCS = 0.447 \exp(0.045(R + 3.5) + \gamma)$	-	Kidybinski (1980)	Coal, Shale, mudstone
$UCS = 2R$	0.72	Singh et al. (1983)	Sandstone, siltstone
$UCS = 0.4RLM - 3.6$	0.94	Sheorey et al. (1984)	Coal
$UCS = 0.994R - 0.383$	0.70	Haramy and De Marco (1985)	Coal
$UCS = 702R - 1104$	0.77	O'Rourke (1989)	Sandstone
$UCS = 2.208e^{0.067R}$	0.96	Katz et al. (2000)	Limestone, sandstone
$UCS = \exp(0.818 + 0.059R)$	0.98	Yilmaz and Sendir (2002)	Gypsum
$UCS = 2.75R - 36.83$	-	Dincer et al (2004)	Andesite, basalts, tuffs
$UCS = 2.22R - 47.67$	-	Aggistalls et al (1996)	Gabbros, basalts
E			
$E = 6.95\gamma^2 R - 1.14 \times 106$	0.88	Deere and Miller (1966)	Varied
$E = 6.9 \times 10^{(1.06 \log(\gamma R) + 1.86)}$	-	Aufmuth (1973)	varied
$E = 0.00013R^{3.09074}$	0.99	Katz et al. (2000)	Syenite, granite
$E = \exp(1.146 + 0.054R)$	0.91	Yimaz and Sendir (2002)	gypsum

UCS = Uniaxial compressive strength (MPa), E = Young's modulus (MPa), R = Schmidt hammer rebound number, γ = rock density (gr/cm³) (Yasar&Erdogan (2004)



Figure 23 Schmidt hammer

3.2.1.2 Shear strength test on discontinuities

This test is conducted for the determining shear strength of discontinuities in rock material. It can be performed in adits, galleries or at the ground level. For testing at the ground level usual size of the block is 50x50 cm and base of the block is tested. This test consists of two stages; first normal load is applied to the sample and vertical displacement is recorded, this load remains constant during the test. Then, tangential load is applied until the failure along the discontinuity plane, that load is recorded as maximum load and displacements are measured. Test is usually performed more times with different normal load and after that results can be shown as $\tau-\sigma_n'$, every test is represented by point and when points are joined, they give a curve defining friction angle and cohesion of the discontinuity (L.I. Gonzalez de Vallejo and M. Ferrer 2011). Figure 24 shows equipment for on-site direct shear test.

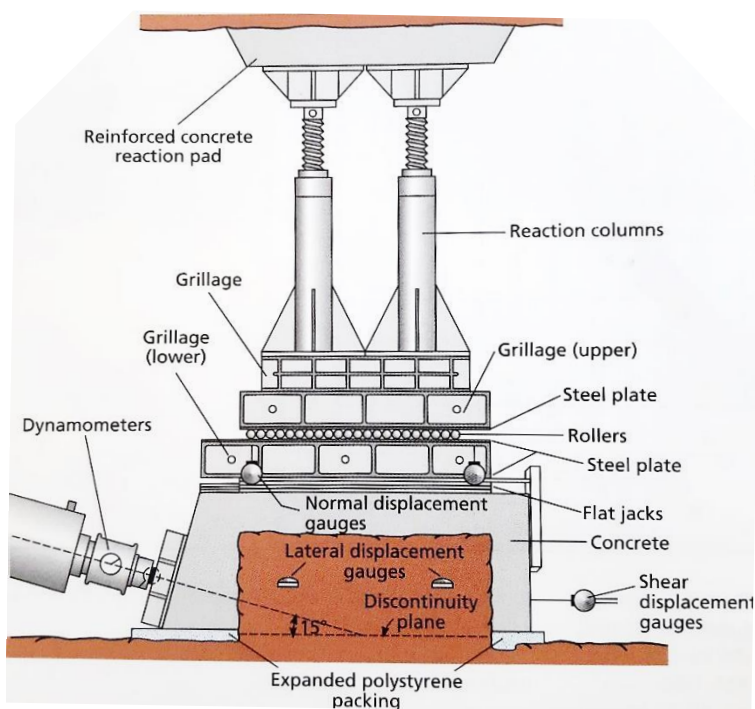

Figure 24 Device for testing shear strength of discontinuities (ISRM 1981).

3.2.1.3 Tilt test

Tilt test is used for estimation of the angle friction of the discontinuities for the calculation of residual angle and joint roughness coefficient. For this test rock specimen should not have cohesive discontinuity filament. Rock specimen is placed on an adjustable plane separated from surface and roughness will be measured. After that plane is tilted until rock sample starts to slide, when that happens angle of the tilt is measured in relation to the horizontal plane, as shown on figure 25. This procedure should be conducted several times. Function that connects the value of α , shear and normal stress is given (L.I. Gonzalez de Vallejo and M. Ferrer 2011):

$$\alpha = \arctan\left(\frac{\tau}{\sigma_n}\right) = \varphi$$

When applied to the Barton and Choubey criterion we can estimate shear strength of the discontinuities with the following formula:

$$JCR = \frac{\alpha - \varphi_r}{\log\left(\frac{JCS}{\sigma_n}\right)}$$

JRC= joint roughness coefficient

JCS= joint wall compressive strength (L.I. Gonzalez de Vallejo and M. Ferrer 2011)

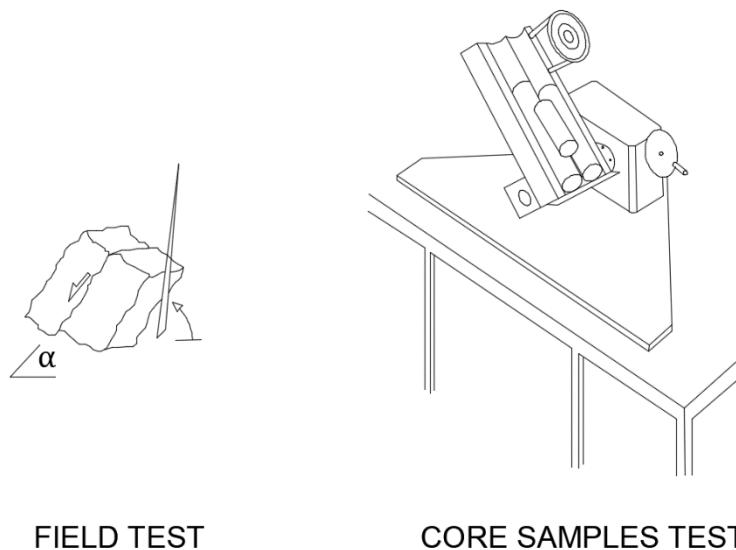

Figure 25 Difference between field tilt test and laboratory version (L. I. Gonzalez de Vallejo and M. Ferrer 2011)

3.2.1.4 P-wave velocity test

P-wave velocity test is non-destructive method for determining geotechnical properties of the rock material. It can be conducted in laboratory and on-site. It is used in geotechnical and mining projects like underground openings, quarrying, blasting, etc. P-wave velocity changes with porosity and degree of saturation.

This test can be conducted on regular and irregular samples. Before every measurement it needs to be calibrated and sample needs to be held with the same pressure as in during calibration (S. Yagiz 2011).

Conducting this test is simple, distance needs to be measured and time needed for the wave from one side to other is shown on device display, from that velocity and dynamic modulus of elasticity can be calculated with the following formulations:

$$velocity(m/s) = \frac{distance(m)}{time(s)}$$

$$E_{dyn} = v^2 * \rho * \frac{1 - v - 2 * v^2}{1 - v}$$

V = velocity(m/s), ρ = density(kg/m³), E_{dyn} = dynamic modulus of elasticity (Pa)



Figure 26 Ultrasonic testing device for P-wave velocity during calibration, distance measuring device and basalt sample.

Figure 26 shows Ultrasonic testing device in Laboratory of Rock Mechanics and Tunneling from Technical University of Graz.

Results of this test can be compared to the table 12.

Table 12 P-wave velocity classification (Anon 1979).

V (km/s)	Description
<2.5	Very low
2.5-3.5	Low
3.5-4.0	Moderate
4.0-5.0	High
>5.0	Very high

3.2.1.5 Equotip

Equotip is portable hardness tester of all surfaces. Device consists of impact body and 3mm tungsten carbide test tip. Tool consists of 3mm in diameter spherical tungsten carbide test tip that is mounted on an impact body. It measures impact and rebound velocity that are processed for determining hardness value that is shown on digital display. There are few types of this device, like type D impact device that delivers an impact energy of 11 Nmm, type C with an impact energy of 3 Nmm and type G 90 Nmm. This is portable tool can also be used for estimating unconfined compressive strength of rock material. When used directly on field specimen should be grinded so the surface is smooth (W. Verwaal and A. Mulder 1993). Figure 27 shows equotip device.



Figure 27 Equotip device (Proceq).

3.2.1.6 Geologist hammer

A geologist's hammer, rock hammer, rock pick, or geological pick is a hammer used for splitting and breaking rocks and investigation of rock formations. In field geology, they are used to obtain a fresh surface of a rock to determine its composition, nature, mineralogy, history, and field estimate of rock strength. Moreover, to format these outcrops to the size that fits into devices for later testing. It is one of the oldest tools used for geological investigations and like that it became a trademark of geologist societies. It can be used for descriptive rock classification, since it largely depends on the person operating this tool, it cannot give exact numbers for strength and other properties. It is useful tool for first time field investigation since it can give approximate values that are later useful for determining of tests that can be used for further examinations. This tool is already implemented in tool box of Analog astronaut space suit. Figure 28 shows geologist hammer.



Figure 28 Geologist hammer (Hardwick & Sons).

3.2.2 Tests conducted in laboratory

3.2.2.1 Brazilian test

Brazilian test is conducted in a laboratory and it is used to determine tensile strength of the rock mass. Tensile strength is important parameter that influences deformability and rock crushing. It is significantly lower than compressive strength in rocks and it is important to determine it when making geotechnical project. Also, cracks significantly affect rock tensile strength. This test requires sample preparation as it needs to be cut in precise shape with smooth surfaces. Samples need to be representative of the examining rock material without visible cracks and cavities. Size of the sample is minimum 54 mm in diameter and thickness must be in between 0.2 and 0.75 times its diameter, figure 29 shows sample shape and device.

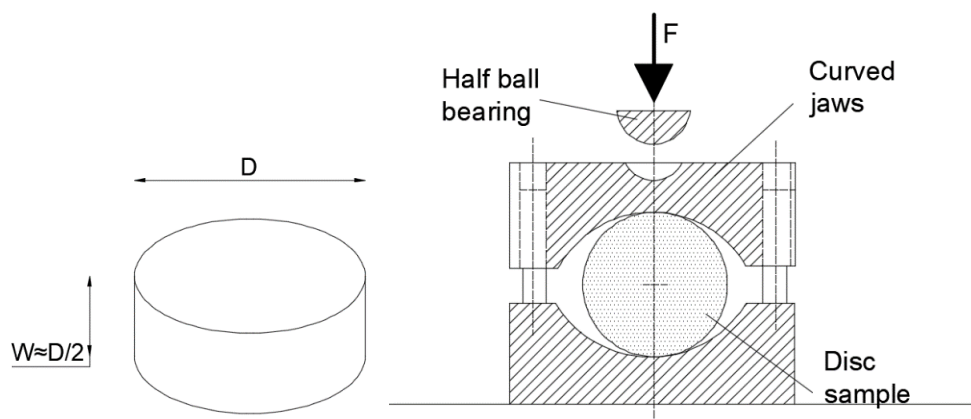

Figure 29 Brazilian test sample and device schematic.

Sample is placed in the device between two steel parts assembled together and they hold the sample in two opposite ends. System then applies constant load with the half ball bearing until the failure of the sample. Failure of the sample must be along its diameter for this test to be successful.

Tensile strength can be calculated with the following formula:

$$\sigma_t = \frac{2 * P(\text{recorded load on failure})}{\pi * D(\text{the diameter of the sample}) * w(\text{width of the sample})}$$

To get reliable results at least 10 tests should be conducted (ISRM 1978).

3.2.2.2 Point load test

Point load test is used for rock classification according to the strength. It can determine compressive and tensile strength of intact rock. This test can be conducted as diameter test, axial test, prismatic test and test on irregular sample, figure 30 shows shape of samples and load direction. Shapes a), b) and c) need to be prepared and sampled more precisely than irregular shape shown on figure d) which can be taken directly from the site without need for precise equipment and tested on site. For this test a force is applied to the rock sample at one

point with the steel cones until the failure of the sample occurs. Result of this test is point load strength index (J. Rusnak and C. Mark).

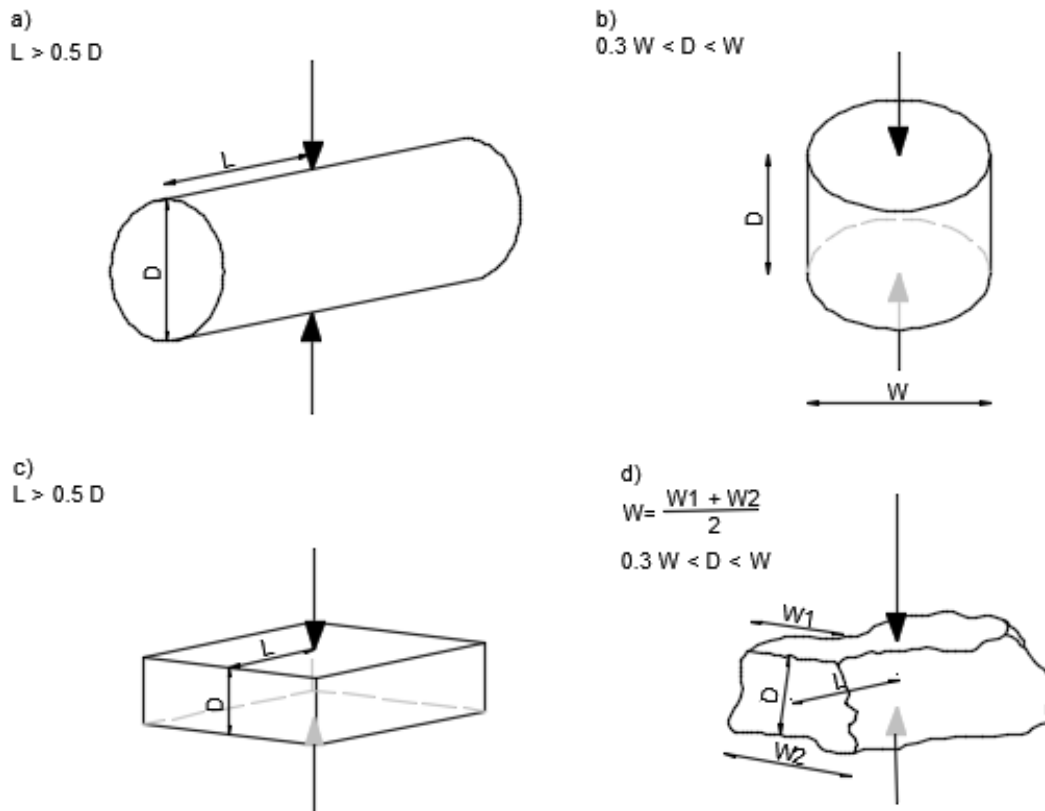

Figure 30 Sample shapes and load direction; a) diameter test, b) axial test, c) prismatic test and d) test on irregular sample shape (ISRM 1985).

After loading the sample, forms of failure can have regular and irregular forms. If sample cracks into two or three similar sized pieces it is considered to be regular and test can be considered valid. If irregular crack due to sample inhomogeneity happens, or if sample just chips a little bit test is considered invalid. Regularity of the cracks after test is shown in figure 31 (ISRM 1985).

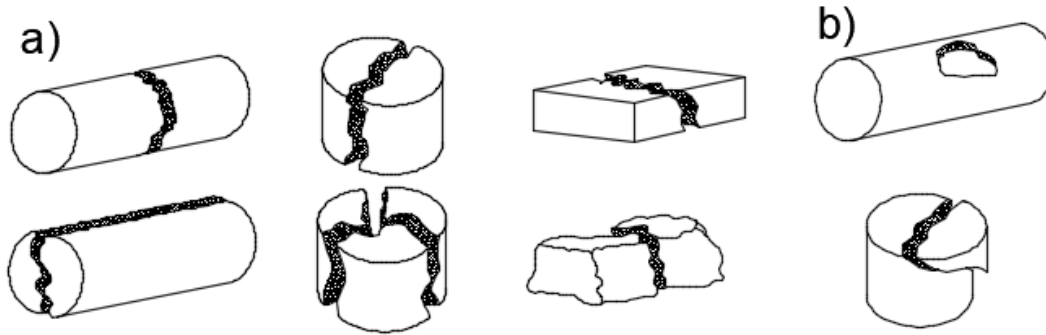

Figure 31 Different form of the sample failure; a) Regular failure of the rock sample: test valid, b) irregular failure of the rock sample: test invalid (ISRM 1985).

Rock is anisotropic material and its mechanical properties can change depending on the layers and load direction. Rock should be tested in both directions and like that maximum and minimum strength can be determined. Figure 32 shows direction of the load compared to anisotropy planes.

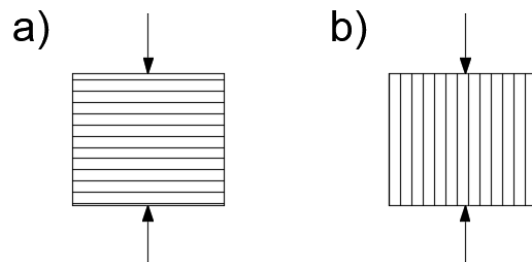

Figure 32 Point load test; a) direction that gives maximum strength and b) direction that gives minimum strength.

This test results in raw data that includes dimension of the sample and load on failure. From that uncorrected point load strength can be calculated:

$$I_s(\text{uncorrected point load strength, kPa}) = \frac{P(\text{load of failure, kN})}{De^2(\text{the equivalent core diameter})}$$

$$De(\text{the equivalent core diameter, for axial, prismatic and irregular test}) = \sqrt{\frac{4 * (W * D)}{\pi}}$$

For diametral test; $De = D$

Because mechanical properties of rock depend on the sample size, correction factor needs to be applied to the equation to get uniform values. For this test reference dimension is 50mm:

$$I_{s50}(\text{corrected point load strength}) = F(\text{size correction factor}) * I_s$$

$$F(\text{size correction factor}) = \left(\frac{De}{50}\right)^{0.45}$$

This test should be conducted few times, and lowest/highest values are excluded, with the rest of data average values can be calculated.

Point load test can be used for estimation of Uniaxial Compressive Strength (UCS) with the following formula:

$$UCS \text{ (Uniaxial Compressive Strength) } = C(\text{constant}) * I_{s50}$$

Figure 33 shows table values for correction factor c from (ASTM 1995), but since values can be linearly interpolated graph is more practical to use in this case.

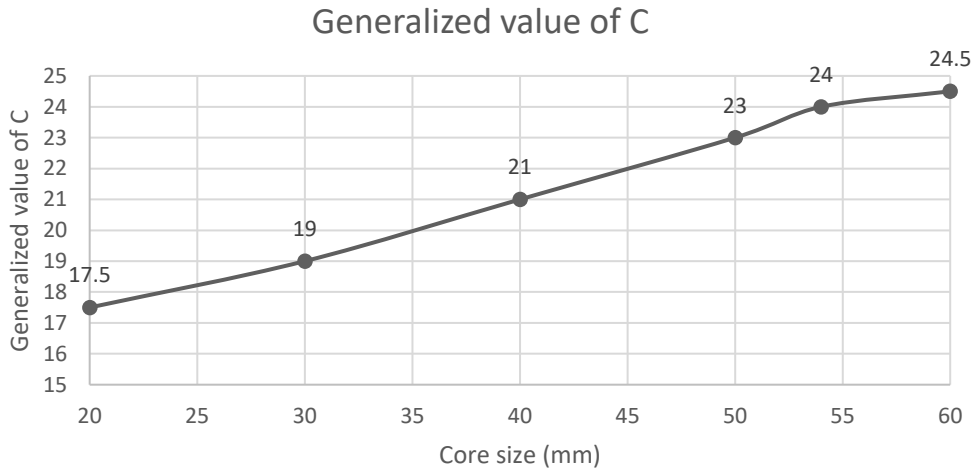

Figure 33 Graphically shown table values for correction factor c from (ASTM 1995).

Figure 34 shows classification of rocks according to strength determined by Point load test.

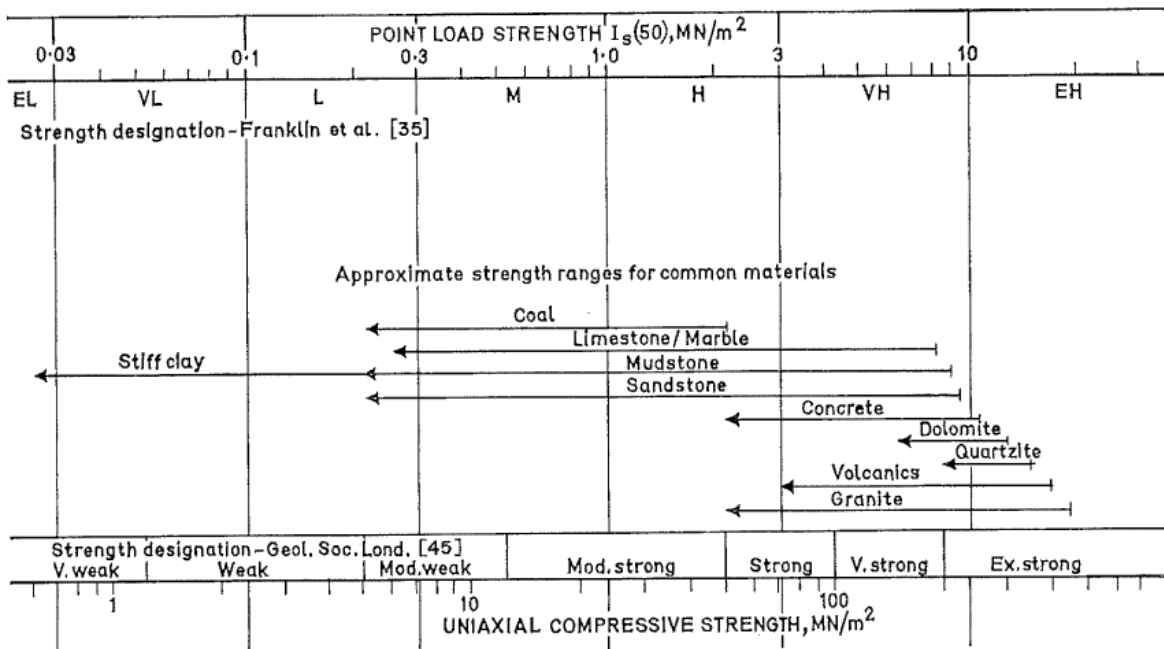

Figure 34 Classification of rocks according to strength determined by Point load test (E. Broch and J.A. Franklin 1972).

Device for the point load test (figure 35) consists of rigid loading frame and a loading measuring system, for this test simple measuring tape or device that can determine size of the sample is needed.

The standard test-set is consisting of:

- Hydraulic cylinder with conical pistons
- Hydraulic pump
- Digital-manometer with pressure and load display

Manometers are precision instruments that are used to measure pressure, which is the force exerted by a gas or liquid per unit surface area owing to the effects of the weight of that gas or liquid from gravity (Geotechnik.com).

- Base plate
- Operator protection set
- Operating manual



Figure 35 Point Load Test, device.

3.2.2.3 Cerchar abrasivity test

Abrasivity test is used for tunneling and excavation purposes. Test consist of measuring wear of the metal pin of a known hardness when scratched on fresh rock. Result of this test is Cerchar abrasivity index (CAI) obtained from pin wear and it can go from Extremely low to extremely high. Schematic of this device is shown in figure 36.

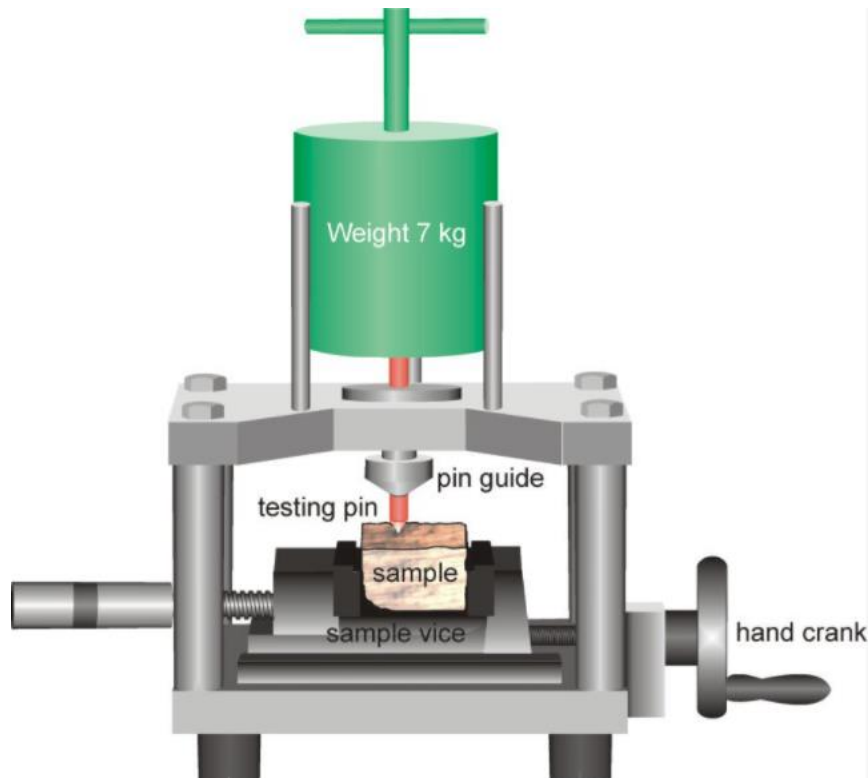

Figure 36 Schematic of Cerchar abrasivity test device (Geotechdata)

Pin has diameter at least 6 mm with a conical angle of 90 degrees. For this experiment tip is slowly drawn 10 mm on the rock surface with a normal static force of 70 N. The wear of the tip is measured under a microscope. Cerchar abrasivity index is a dimensionless unit and it is calculated by multiplying the surface of the tip after the test stated in units of 0.01 mm by 10. For this test to be accurate it needs to be conducted minimum ten times and the CAI calculated as the mean value.

The CAI test is conducted on a rough, freshly rock sample surface. CAI can be lower on smooth surfaces (L. Zhang 2017).

Figure 37 shows some of the typical values after Cerchar test for Limestone, Clay, Sandstone, Marble, Quartzite, Gneiss, Amphibolite, Schist, Granite, Basalt and Rhyolite.

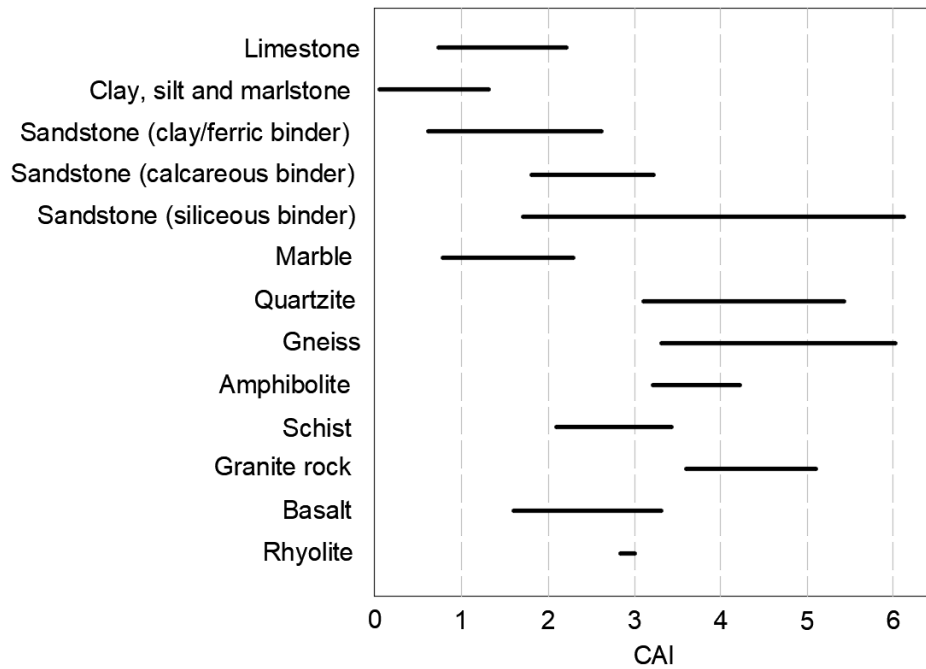

Figure 37 Typical values of CAI for different rock types, based on data from Plinger et al. (2003), Maloney (2010) and Deliormanli (2012).

3.3. Classification of rock mass

Geomechanical classification of the rocks originally came from observation of the rock mass characteristics and with help of simple tests. Classifications usually consider strength of the rock material, RQD (rock quality designation) index, spacing, condition and orientation of discontinuities, geological structure and state of stress. Today most commonly used classifications are RMR and Q classification, used for tunneling applications (L.I. Gonzalez de Vallejo and M. Ferrer 2011).

RMR was developed in 1973 by Bieniawski and updated later on. It connects quality indexes with parameters of the rock mass. This classification takes uniaxial compressive strength of intact rock, degree of fracturing (RQD), spacing, orientation and condition of the discontinuities and groundwater (L.I. Gonzalez de Vallejo and M. Ferrer 2011). Table 13 shows guidelines for tunneling excavation and support.

Q classification was conceived on many analyses of tunnels during construction and underground excavations by Barton, Lien and Lunde from the Norwegian geotechnical institute. It is mainly used for determining rock mass characteristics for tunnel support system. It is based on parameters: RQD, number of crack sets, crack roughness index, index of crack changes, crack water factor and stress reduction factor for in-situ conditions.

Terzaghi classification is one of the first used classifications of rock mass and it is based on rock mass load (K. Terzaghi 1943). This method is modified through time.

There are other methods for rock mass classification like:

- Lauffer classification (Laufer, 1958)

- Rock quality Designation classification RQD (Deere et.al. 1967)
- Rock Structure rating classification RSR (Wickham et.al. 1972)

Table 13 Guidelines for excavation according RMR system by Bieniawski.

Rock mass class	Excavation	Rock bolts (20 mm diameter, fully grouted)	Shotcrete	Steel sets
I – Very good rock <i>RMR</i> : 81-100	Full face, 3 m advance	Generally no support required except spot bolting		
II – Good rock <i>RMR</i> : 61-80	Full face , 1-1.5 m advance. Complete support 20 m from face	Locally, bolts in crown 3 m long, spaced 2.5 m with occasional wire mesh	50 mm in crown where required	None
III – Fair rock <i>RMR</i> : 41-60	Top heading and bench 1.5-3 m advance in top heading. Commence support after each blast. Complete support 10 m from face	Systematic bolts 4 m long, spaced 1.5-2 m in crown and walls with wire mesh in crown	50-100 mm in crown and 30 mm in sides	None
IV – Poor rock <i>RMR</i> : 21-40	Top heading and bench 1.0-1.5 m advance in top heading. Install support concurrently with excavation, 10 m from face	Systematic bolts 4-5 m long, spaced 1-1.5 m in crown and walls with wire mesh	100-150 mm in crown and 100 mm in sides	Light to medium ribs spaced 1.5 m where required
V – Very poor rock <i>RMR</i> : < 20	Multiple drifts 0.5-1.5 m advance in top heading. Install support concurrently with excavation. Shotcrete as soon as possible after blasting	Systematic bolts 5-6 m long, spaced 1-1.5 m in crown and walls with wire mesh. Bolt invert	150-200 mm in crown, 150 mm in sides, and 50 mm on face	Medium to heavy ribs spaced 0.75 m with steel lagging and forepoling if required. Close in- vert

3.4. Mineralogical investigation

Every rock has its specific mineralogical content and composition by which it can be identified. Mineralogy is part of geology specialized in scientific investigation of rock minerals and its composition. It includes mineral origin investigation and formation, mineral classification and their distribution (W.D. Nesse 2012).

3.4.1 Raman Spectroscopy

Raman Spectroscopy is chemical identification and characterization of the molecular structures of the soil or rock sample. Natural rocks are complex and they consist of one or more combinations of minerals, and each one of those minerals is defined by its chemical composition and structure. Raman effect is highly sensitive to slight difference in chemical structures. It is practical tool for studying geologic material, also fast and reliable (E. Lancelot 2010). Figure 38 shows Raman spectrum of olivine, as a result of this test (E. Lancelot 2010).

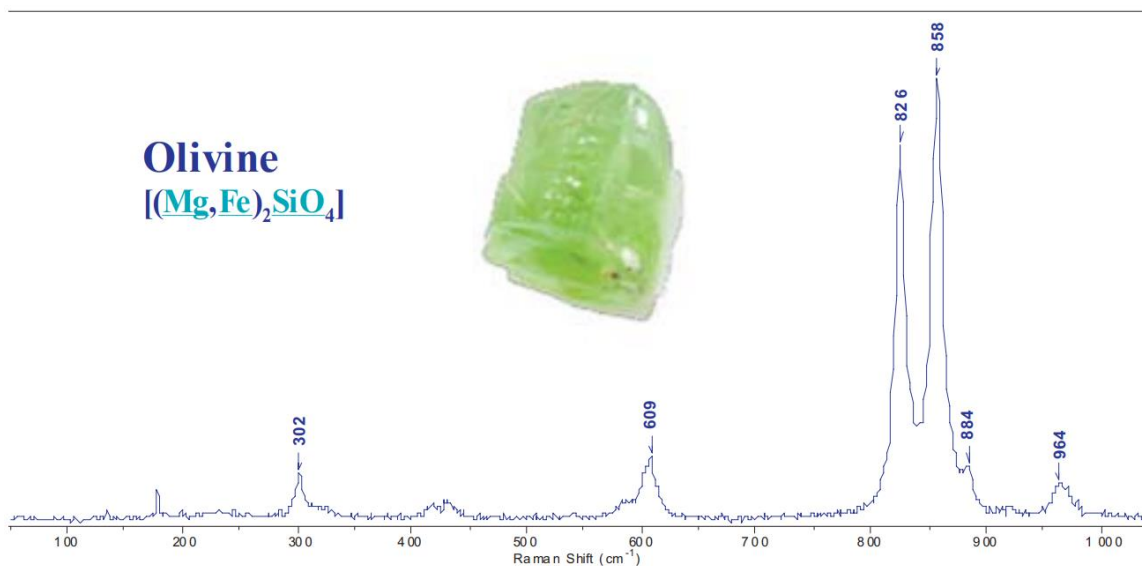

Figure 38 Raman spectrum of olivine (T. Warwick)

Advantage of Raman Spectroscopy is that sample doesn't need special preparation and it can test variety of samples, also samples are small. Results of this test are Raman frequency that is used for identification of minerals, stress or strain state from changes in peaks, crystal symmetry and orientation (T. Warwick).

4. Potential problems in Martian conditions

In this section problems with analyzed devices from section 3 are summarized in tables with described possible problems that might occur when using on Mars, also with conditions that might affect these tools and machines like gravity, pressure, water, low temperatures and if it is viable size or it needs to be reduced in some way.

4.1. Characterization of soils

Grading system for these tests/devices is both binary and descriptive, mark "x" means that it is not directly affected and mark "√" means that the method / device is directly affected by mentioned condition in first row in the table. Brief description is given in a row below the binary grade. This grading system is simple and could be used for later more detailed analysis, but that would have to be study for itself, for the purpose of this study this grading system is sufficient.

Table 14 On-site tools and tests for soil investigation that can be done by humans.

Device/Test	Gravity	Pressure	Lack of liquid water	Low temperatures	Viable size for field
General soil description	x	x	x	x	√
This test is not directly affected by these conditions, but it is affected by the fact that astronauts can't really feel the soil by hands, so description would have to be based on visual content or samples have to be properly brought to the base, that means they need to be contained in thermal container so they keep their in-situ properties, like temperature and/if ice is present it stays in solid state.					
Pressuremeter test	√	√	x	x	x
This test is affected by gravity and the pressure difference since it is measuring soil pressure, the size of this device is questionable, but main lack of this test is that it needs a borehole that is hard to make on Mars because it would require some type of boring machinery, if reduced in size it could be possible with some conversions in pressure, also compressor in this device needs to be adapted in a way that is sealed more tightly. It would be difficult to operate with this device in full space suit, and it could be possible dangerous, since some parts could rupture the suit and endanger human.					
Soil classification	x	x	x/√	x	√
This test is not directly affected by gravity and pressure, but for soil classification of smaller particles water is needed. For bigger particles classification could be conducted by sieving. Bringing samples in in-situ conditions to the base would be necessary.					

In this case it would be best to describe material on site with as much detail as possible, write exact location where that soil is described, collected into sample bag, and preserved in thermal container so it stays in similar temperature as it is on site, like that it could be later analyzed in base laboratory. It is always important to keep in situ conditions as much as possible. Table 14 shows on-site tools and tests for soil investigation that can be conducted by humans; general soil description is an observational method and it doesn't need specific device to be conducted, but it is a crucial thing to do before conducting tests, it can give many important information, information collected with this method can be recorded in ways accessible during the EVA. Pressuremeter test requires big machinery but that could be adapted to be smaller it is affected by gravity and pressure so conversion needs to be done before comparing results with ones made on Earth, also it requires borehole that can also be made smaller with the respect of adapted machine, but that would be study for itself. Soil classification can be done on Mars but the parts with classification of bigger particles that can be conducted without liquid water, since determining smaller particle percentage requires sedimentation or similar methods, also determining plasticity and liquidity index involves water. For classifying bigger particles sieves are needed.

Table 15 On-site tests for soil investigation that have to be executed from bigger machines like crawlers or vehicles.

Test	Gravity	Pressure	Lack of liquid water	Low temperatures	Viable size for field
Standard penetration test	✓	x	x	x	x
This test is affected by the gravity because it depends on the weight of the hammer, so it could be adapted in a way that we convert that weight according to the difference of gravity between planets, but the size of this device is questionable, also it would be necessary to connect it to the rover and difficult to use in full space suit.					
Static penetration test	x	x	x	x	x
This test is slightly affected by the gravity because cone is force pushed into the ground with constant rate and not with the force of hammer, but the size of this device is questionable, also it would have to be connected to the rover.					
Field Vane test	x	x	x	x	x
This test is not that affected by gravity since it is using torsion as testing force, but the size of this device is questionable, it would be hard to operate in full space suit.					

Table 15 shows on-site tests for soil investigation that have to be executed from bigger machines like crawlers or vehicles, they can be also conducted from rovers that will already be on Mars for other purposes like transportation of equipment. All those devices would have to be adapted for usage from rovers and also they would be difficult to operate during EVA.

Table 16 Laboratory soil testing, conducted by humans

Test	Gravity	Pressure	Lack of liquid water	Low temperatures	Viable size
Grain size analysis	✓	x	✓/x	x	✓
Grain size analysis for the bigger particles can be conducted without liquid water, but for the smaller particles like silt and clay water is needed. It is not that complicated, also it can be conducted in lower gravity procedure might be affected but I think that results should be the same. Size is viable because sieves can be adapted to be smaller if needed, also they could have mechanism to be disassembled if needed.					

All bigger devices are hard to adapt, first off all it would be extremely expensive to bring them to Mars, and then comes the problem of operating this machinery, all small pieces like screws, buttons and levers would have to be adapted to be bigger, so that astronaut can fix machine fully equipped during EVA if something goes wrong. All devices and tools for Martian exploration should be as simple as possible and easily adapted with less or no parts that are easily breakable. Table 16 shows soil test conducted in laboratory, it is a simple test that requires arranged sieves and sample, they have to be vibrated so smaller particles can fall to the last sieve, on Earth machines are doing that, but for purpose of Martian exploration that can be done by moving sieve by hand or with some simpler and smaller machine.

4.2. Characterization of rocks

Next devices are investigated from geotechnical perspective.

If one day liquid water on Mars would not be that scarce, laboratory devices that require water should be reconsidered, but also analysis of what kind of experiments should be done on Mars and what kind of the results are required. This needs to be done more detailly so it can be decided which of these devices should be reconsidered for adaptation. Adaptation of these devices would be expensive, since better, lighter materials should be used, and all some pieces would have to be custom made and that is always a problem regarding costs and time.

Table 17 On-site tools and tests for rock investigation that can be done by humans.

Device/Test	Gravity	Pressure	Lack of liquid water	Low temperatures	Viable size
Schmidt hammer	✓/x	x	x	?	✓
This device is affected by gravity if used in vertical position but it can be converted easily, if used horizontally, gravity wouldn't affect it much. It is not affected by different pressure and temperature, nor it uses liquid water to function properly, size of this device is small and it could be used in Martian conditions with low adaptation. Maybe better grip could be included since space suit has clumsy, big gloves. Results of this device usually need to be written down on paper, but small display with memory for the results could be added, also it would be hard to operate with this device if rock surface that we want to test is on the floor and for the fully equipped astronaut is very hard to kneel and do this test, this problem could be fixed by adding telescopic rod as extension.					

Tilt test	✓	x	x	x	✓
On site version of this test is viable for usage on Mars since it doesn't require much equipment and measurements are not affected by outside factors, since only angle needs to be measured. But sample could be affected by outside factors, also sample needs to be acquired from a borehole.					
P-wave velocity	x	x	x	?	✓
P-wave velocity device is not directly affected by gravity or pressure and it should be able to work in Martian conditions without mechanical adaptation, also device can be made smaller for transportation purposes. Results might be affected by lower temperatures. This test can also be conducted in laboratory, but in that case, samples have to be preserved and brought to the base in thermal container. Test should be done immediately after removing it from the container so results are more precise and correct.					
Equotip	x	x	x	?	✓
It is small portable device so in terms of instrument size it would be viable. I am not sure how temperature change would affect this device, needs more testing. It contains lots of small pieces and it would be hard to operate on field in full space suit.					
Geologist hammer	✓	✓	x	x	✓
It is affected by the gravity in a way that hammer would weigh less in Mars and that could affect results, but since this tool is not a precise device that gives exact numbers, it is not that important, in this case it would be used more for formatting specimens and descriptive analysis. This tool is already used in analog Mars mission and it is essential part of the tool box that is attached to Analog Astronaut suit. Moreover, I have observed Analog Astronaut Thomas Wijnen picking up hammer and moving it on another place relatively easily.					
Rock classification	x	x	x	x	✓
This test is not that affected by gravity and pressure, since this method uses mostly visual aspect.					

Table 17 shows on-site tools and tests for rock investigation that can be done by humans. None of these tools and devices require water to function. Schmidt hammer is a simple tool that can be easily adapted, it is small device, AMADEE-15 Mars Mission Simulation proved that can be performed under simulated Martian conditions. Tilt test is simple test that can be done both on site and laboratory and it doesn't require much equipment, only problem that could occur is if astronaut during EVA needs to bend to the floor to conduct this experiment, but it can easily be solved and it can be conducted on higher flat surface that is available at that moment in the field, or samples can be brought to the laboratory in the base. P-wave velocity test is small and simple device that can be used both on site and in laboratory since it is transportable, before use it needs to be calibrated. Equotip and geologist hammer are also small and transferable. Moreover, geologist hammer is a tool that is already contained in tool box on suit AOUA made by ÖWF. Rock classification would be the first thing to do after arriving on site it is visual method and data can be recorded digitaly for easier analysis later.

Table 18 In habitat tools and tests for rock investigation that require bigger machines and conducted in laboratory.

Device/Test	Gravity	Pressure	Lack of liquid water	Low temperatures	Viable size
Point load test	✓	x	x	✓	x
This test is slightly affected by gravity but not much since the force used for this experiment is much greater, but strength of the rock specimens will be different in different temperatures, so before comparing it to Earth's rock specimens we need to take that into account. This test would have to be conducted in a base laboratory and not on field. This test has to be conducted in some kind of box that will contain all small pieces that could potentially rupture suit and/or habitat because sometimes high force has to be applied. Hydraulic system needs adaptation against low temperatures and needs to be dust proof.					
Shear strength test on discontinuities	x	✓	x	x	x
This test is not affected by gravity since it depends on horizontal force, but vertical force should be added accordingly to the lower gravity force. Size of this device is questionable. This test would have to be conducted in a base laboratory and not on field.					
Cerchar abrasivity test	x	x	x	✓	✓
This test is not directly affected by gravity since much larger force is needed for conducting this test, same with the pressure, but low temperature could affect samples properties and it needs to be taken into consideration. Size of this device could be adapted for transportation purposes.					
Brazilian test	✓	x	x	✓	x
This test is slightly affected by gravity but not much since the force used for this experiment is much greater, but strength of the rock specimens will be different in different temperatures, so before comparing it to Earth's rock specimens we need to take that into account. This test would have to be conducted in a base laboratory and not on field. Problem with this test is preparation of the sample that needs more equipment for sample formatting, also it needs to be precise and that could cause problems.					

Table 18 shows in habitat tools and tests for rock investigation that require bigger machines and conducted in laboratory, since bigger machines could be problem to transport to Mars they need to be carefully considered before bringing on Mars. All of these devices could be adapted to be smaller and lighter if made with different materials. Point load test is maybe the best and most viable machine since it can be used with irregular size samples compared to the brazilian test that requires very specific shape of the sample that could be hard to make on Mars.

Table 19 Device for mineralogical investigation

Device/Test	Gravity	Pressure	Lack of liquid water	Low temperatures	Viable size
Raman spectroscopy	x	x	x	x	✓
This device is already used on rovers for exploration of Mars and in Analog missions conducted by the ÖWF.					

Table 19 shows device for mineralogical investigation Raman spectroscopy and it is already been used in Analog missions conducted by the ÖWF.

Because of uncertainty about how temperature might affect Schmidt hammer test results and P-wave velocity in rock material I decided to conduct experiments on room temperature samples and on cooled samples, to compare their result and see if they would change and whether that change is significant or not.

I also want to show how point load strength of the basalt changes at different temperatures.

These devices can be used on irregular shaped samples which is a plus for usage Mars because it would be difficult to cut rocks and format them in exact shapes.

5. Laboratory investigation

After analysis of devices and tools in chapters 3 and 4 I have decided to test three devices when temperature changes and compare results to see whether that change exists and if yes is it significant or not.

Temperature change is tested because at first it might seem that it is not that relevant on Earth because if we take sample on room temperature of 24°C outside, that same temperature is most likely to be similar in the laboratory, there are exceptions in summer and winter. But on Mars temperature outside can be significantly lower than temperature in habitat so it is important to preserve that outside temperature when bringing samples.

5.1. Material sampling

For the purpose of this thesis, I collected basalt samples from the quarry in Klöch, Austria. Samples are collected from the ground; they were a result of material extraction from a quarry, they are mined from deeper layers and not directly from surface. Satellite picture of Austria and the site of the quarry is shown on figure 39. On Earth collecting samples in this way is relatively easy because quarries exist, but there are no quarries on Mars and samples will have to be taken in some other way, or from the surface.



Figure 39 Location of sample extraction site, red dot pointed with arrow; quarry Klöch, near Graz, Austria.

5.2 Methods of investigation

Chosen methods of investigations are made according to the tables mentioned in section 4, since testing gravity and pressure dependency is more difficult to conduct, I decided to test how important the temperature difference is for the final test result. P-wave velocity (see section 3.2.1.4), Schmidt- hammer test (see section 3.2.1.1), Point load test (see section 3.2.2.2).

In the next section more detailed explanation are given, on how I changed temperature and how results changed.

5.3 P-wave velocity test results

To simulate temperature change I tested samples on high and low temperatures, also dry the samples to see how water content affects results. I have chosen next conditions:

1. Test was conducted on samples in-situ water content and room temperature conditions (table 20).
2. Test was conducted on dry samples after 3 days in 105°C and temperature range from 28°C to 37°C (table 21).
3. Test was conducted on dry cooled samples on -15°C (table 22)



Figure 40 Basalt samples used for P-Wave velocity test.

Table 20 Results from samples in-situ water content and room temperature conditions

	Mass (natural moisture) (g)	Distance (mm)	Time (μs)	Velocity (m/s)
Sample 1	1465.5	90.74	16.1	5636.0
24°C		91.37	16.7	5471.3
		69.62	12.6	5525.4
Sample 2	488.5	61.49	115.5	532.4
24°C		39.72	27.6	1439.1
Sample 3	774.4	87.9	16	5493.8
24°C		57.46	11.4	5040.4
Sample 4	1936.1	106.2	20.2	5257.4
24°C		66.48	12	5540.0
		111.88	23.4	4781.2
Sample 5	989.9	47.57	13.9	3422.3
24°C				

Table 21 Results from dry samples after 3 days in 105°C and temperature range from 28°C to 37°C

	Mass (dry) (g)	Water mass (g)	Distance (mm)	Time (μs)	Velocity (m/s)
Sample 1	1454.6	10.9	90.51	20.3	4458.6
37°C			91.71	19.4	4727.3
			71.02	17.4	4081.6
Sample 2	477.9	10.6	61.39	109.2	562.2
28°C			39.9	30.8	1295.5
Sample 3	769.9	4.5	87.93	18.5	4753.0
34°C			57.85	13.4	4317.2
Sample 4	1923.5	12.6	106.1	23.5	4514.9
36°C			65.37	14.3	4571.3
			111.88	30	3729.3
Sample 5	982.5	7.4	46.44	17.3	2684.4
34°C					

Table 22 Results from dry samples and temperature -15°C

	Mass (dry) (g)	Distance (mm)	Time (μs)	Velocity (m/s)
Sample 1	1454.6	90.2	18.1	4983.4
-15°C		91.5	19.2	4765.6
		71.3	15.4	4629.9
Sample 2	477.9	61.49	117.2	524.7
-15°C		40.31	28.8	1399.7
Sample 3	769.9	88.69	16.8	5279.2
-15°C		58.46	11	5314.5
Sample 4	1923.5	105.94	23.6	4489.0
-15°C		66.51	13.5	4926.7
		112.37	27.4	4101.1
Sample 5	982.5	47.55	16	2971.9
-15°C				

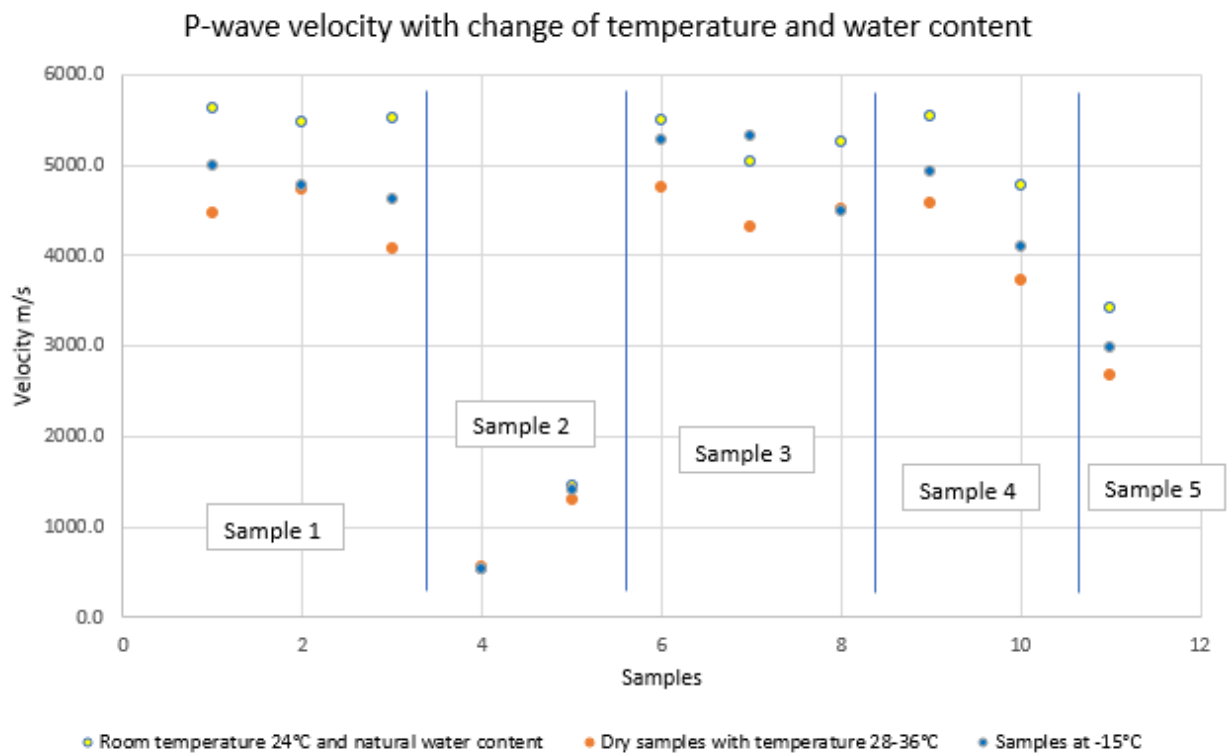

Figure 41 Graph with results from tables 20, 21 and 22 of the P-wave velocity test

5.3.1. P-wave velocity result interpretation

In tables 20, 21 and 22 are shown results of the P-wave velocity test conducted on samples in different temperature conditions. We can see that sample 2 has lowest P-wave velocity, but if we look more closely to that sample, we can see that it has small cavities visible from the outside, that same sample was tested with Point load test, result is shown in table 26 (Sample 2) and there it also has lowest value that is connected with those cavities. Other results are more or less within expected values for basalt samples. Figure 40 shows basalt samples used for the P-wave velocity test.

Figure 41 shows graphical representation of results given in tables 20, 21 and 22. In yellow are shown results from the samples on room temperature with natural water content and here we can see that these results have highest velocity values. In orange are shown results from the dry samples with temperature range from 28°C to 36°C, it is range of temperature because I testes them after drying in the oven and I waited for them to cool so I can safely handle them, and they are not the same size so smaller samples cooled faster than bigger ones. In blue are shown cooled samples on -15°C and we can see that they are in between yellow and orange ones. Most important thing here to see is that they are not the same and that temperature change affects these results.

5.4 Schmidt hammer test results

To simulate temperature change I tested samples on high and low temperatures. I have chosen next conditions:

1. Test was conducted on room temperature conditions (table 23).
2. Test was conducted on cooled samples on -15°C (table 24).



Figure 42 Basalt samples used for Schmidt hammer test

Table 23 shows results of Schmidt hammer test performed on room temperature of 24°C for basalts: Sample 1 and Sample 2.

Table 23 Results from samples in-situ water content and room temperature conditions.

Sample at room temperature: 24°C			
Sample 1		Sample 2	
	48		37
	58		52
	58		54
	55		46
	56		48
	64		46
	52		44
	66		54
	55		45
	60		51
average	57.2		47.7

Table 24 shows results of Schmidt hammer test performed on -15°C for basalts: Sample 1 and Sample 2.

Table 24 Results from dry samples -15°C temperature conditions.

Sample at temperature: -15°C			
Sample 1		Sample 2	
	44		41
	55		48
	61		45
	56		42
	61		46
	43		53
	54		46
	52		44
	52		50
	60		40
average	53.8		45.5

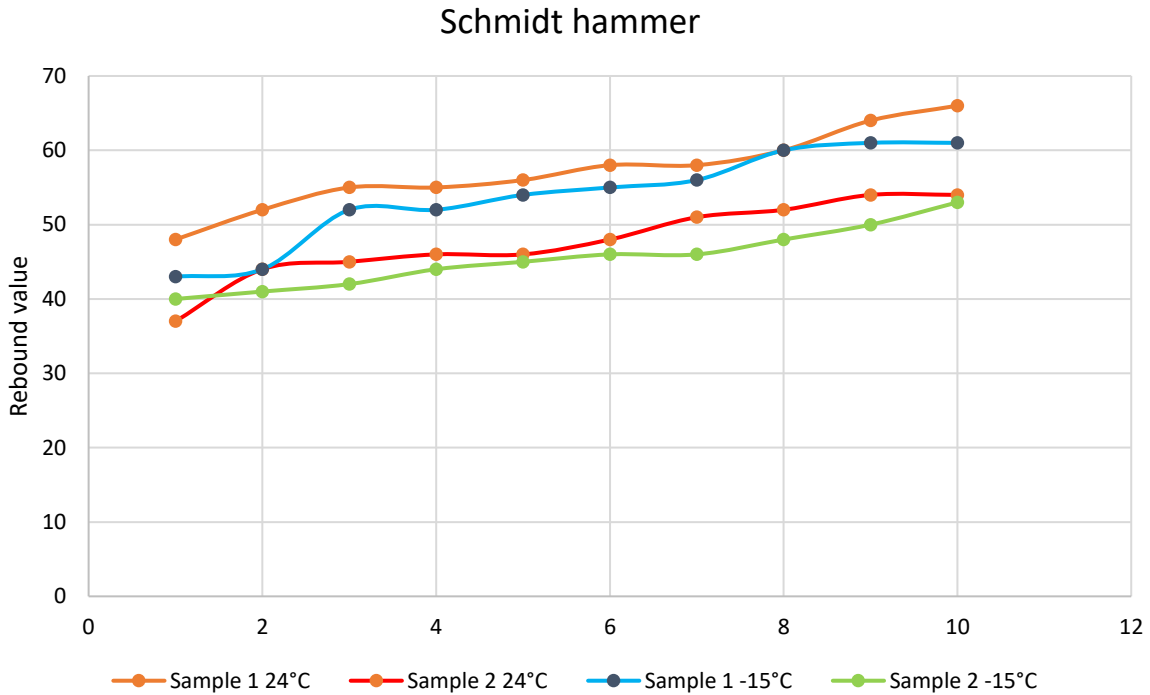

Figure 43 Graphical display of test results from tables 23 and 24.

5.4.1 Schmidt hammer test result interpretation

Figure 42 shows samples used for Schmidt hammer test compared to the measuring tape. For this test I fixated the samples to the floor so they are completely static. Samples surfaces are flat so that results can be more precise. I conducted vertical test.

Figure 43 shows graphical display of Schmidt hammer test results, if we compare Sample 1 in room temperature and in -15°C we can see that there is a slight difference in rebound values, cooled sample had lower rebound values, same happened with Sample 2 and it had lower values from Sample 1 in general. Sample 2 had lowest values in cooled state.

5.5 Point Load Test results

To simulate temperature change I tested samples on high and low temperatures, also dry the samples to see how water content affects results. I have chosen next conditions:

1. test was conducted on samples in-situ water content and room temperature conditions (table 25).
2. test was conducted on dry cooled samples on -15°C (table 26)

Figure 44 shows samples after the point load test with marker for comparison of size.



Figure 44 Samples after the Point Load Test.

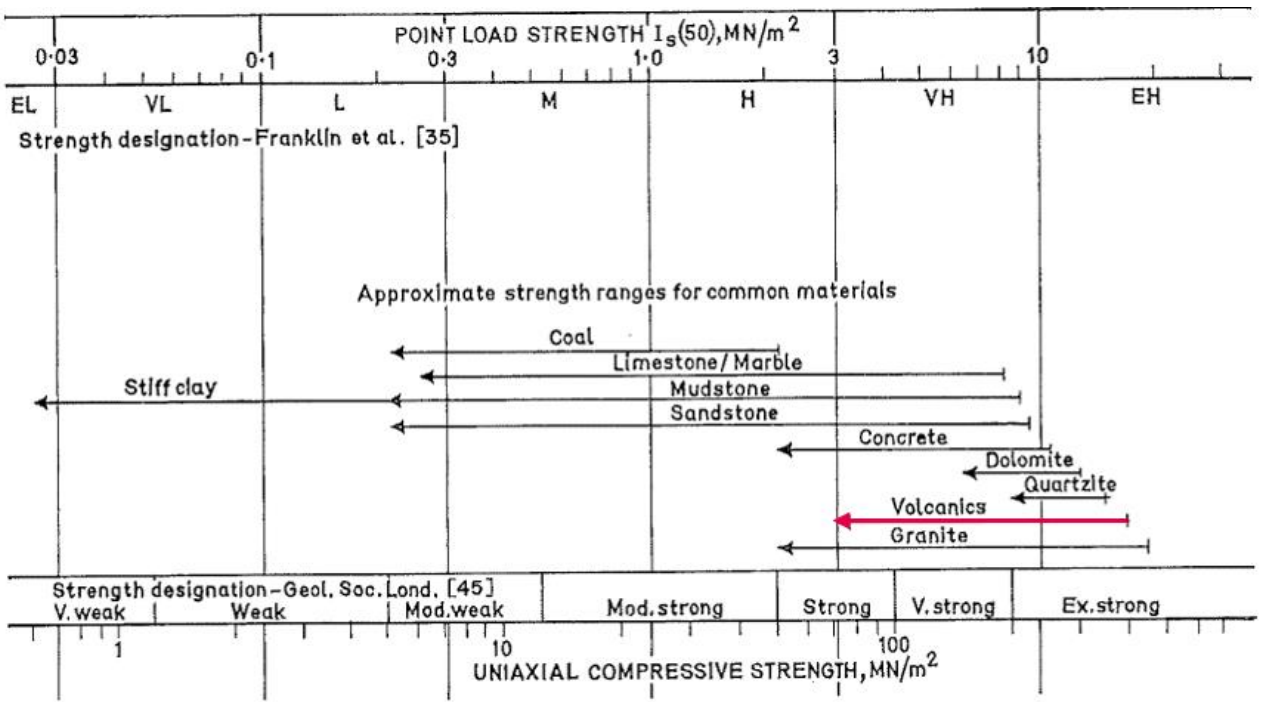

Figure 45 Expected values for Point Load test, marked in red values for volcanic material.



Figure 46 Sample 2

Table 25 Results from samples in-situ water content and room temperature conditions.

	D- Distance (mm)	W-width (mm)	load (kN)	De - equivalent core diameter (mm)	Is - uncorrected point load strength(kPa)	size factor	Is 50
Sample 1	32.4	75.2	3	55.71	966.56	1.05	1014.77
Sample 2	53.83	116.41	33	89.35	4133.99	1.30	5368.03
Sample 3	30.35	57.4	5	47.11	2253.04	0.97	2193.45
Sample 4	44.15	many small pieces	31	-	-	-	-
Sample 5	44.55	123.35	11	83.67	1571.36	1.26	1981.03
						average	2639.32

Table 25 shows results from in-situ water content samples conducted in room temperature of 24°C and table 26 shows results from dry and cooled to -15°C samples.

Table 26 Results from dry samples -15°C temperature conditions.

	D- Distance (mm)	W-width (mm)	load (kN)	De - equivalent core diameter (mm)	Is - uncorrected point load strength(kPa)	size factor	Is 50
Sample 1	66	48.4	17	63.79	4177.62	1.12	4661.60
Sample 2	40.39	45.87	1	48.58	423.71	0.99	418.25
Sample 3	52	41.33	35	52.32	12784.06	1.02	13048.10
Sample 4	44	77.45	23	65.89	5298.14	1.13	5998.57
	38	48.13	13	48.27	5579.73	0.98	5491.95
Sample 5	45.8	67.11	21.5	62.57	5491.05	1.11	6074.28
						average	5948.79

5.5.1 Point Load Test result interpretation

If we compare average result from test on room temperature and on -15°C we can see that cooled samples had higher point load strength. Here we have to be careful because samples in tables 25 and 26 are not the same, since this is a destructive method, they couldn't be retested, but I have chosen similar samples, and they were all acquired on the same site. In table 25 Sample 2 (figure 46) is the same as Sample 2 in tables 20, 21 and 22. After point load test sample broke and inside it had more filled cavities that resulted in lowest values on Point Load Test. All other results are close to expected value range (figure 45).

6. Discussion

In this thesis I analyzed devices and tools made on Earth and thought about how could they be transferred to Martian conditions, for that to be possible I wrote short analysis of Martian conditions and geology. I also mentioned and analyzed tools and devices that are already used on Mars like rovers and their equipment and manned missions to Moon. Moreover, analog Mars missions are preparing humans for real mission on Mars one day. It is very important to simulate all factors and conditions as realistic as possible. They are conducted by the ÖWF.

To get a better understanding of the movement possibilities of the fully equipped Analog Astronaut I visited ÖWF when they were conducting donning process of the AOUDA suit. They showed me a part of preparation for analog mission. Fully equipped analog astronaut proved that grabbing smaller objects may not be that big problem, he picked up the pen and write down on the specimen bag, he also had no problems taking the regular sized geological hammer from the table and moving it to another location. Moreover, he successfully picked up soil sample with tool and stored it into a sample bag. However, it would have been easier if the tools had wider and better grips, considering that this suit testing lasted for one hour, and real EVA mission will last up to 5 hours and regarding suit weight and other restrictions when fully equipped it would be good to adapt grips on tools.

Because of the uncertainty of how temperature difference would affect results for some tests I decided to do few experiments. I chose three different tests on rocks; one that can be done on-site, one that has to be done in a laboratory inside of the habitat, and one that can be both inside and outside.

- Schmidt hammer for on-site investigation, but for practical purposes I brought samples to the laboratory and conducted this experiment there.
- Point Load Test as in habitat experiment.
- P-wave velocity as both inside and outside experiment.

For all tests I used irregular sample shapes, since formatting to exact shapes would be very difficult on Mars, and that could have caused some small result deviations. P-wave velocity test showed difference between results on the room temperature and on the cooled samples. Highest P-wave velocity is recorded in room temperature samples with natural water content, and lowest P-wave velocity is recorded in dry samples. The most unexpected result was from Schmidt hammer test, I thought that results would be the same regarding the temperature difference, but there was a deviation in results between different temperatures. Point Load Test was not conducted on exactly same specimens since it is destructive method. There was divergency in results between different temperatures of the samples, cooled samples had much higher strength then room temperature ones which was expected. Sample 2 from the figure 46 behaved as expected, since that sample was different from the rest, it had cavities and different density was noticeable.

I compared raw data gathered from experiments and not derived parameters that we would usually calculate. My goal was to show that results that we get from experiments would not be the same.

From all experiments I concluded that temperature is important aspect that can't be ignored in Martian exploration. Especially since I used smaller temperature difference (lowest possible temperature that we could simulate in laboratory was -15°C) and as higher temperatures I

used room temperature of 24°C. On Mars that temperature difference is much greater and has more impact on samples.

Collecting samples on Earth was easy because I could just go to quarry and get samples of material, but on Mars that is not possible to do. On Mars samples would have to be taken from the surface and that would affect results.

Devices analyzed in this study can work on Mars with some adaptations, some doesn't require significant adaptation (table 27 and 28). Bigger machines need more analysis since they require a lot of space, they would need to have very good reason to be sent on Mars and if so, they would have to be reduced in size, different materials would have to be used to make them lighter and more compact. Table 27 contains summary of tools and devices for soil investigation with answers on questions: *"Can it work on Mars (yes, no or it can work with adaptation)?"*, *"Why (description)?"* and *"Possible problems that can occur when using on Mars (description)?"*

More tests on these devices need to be conducted in order to make proper decision what can and what can't work on Mars. I did not test and analyzed them all because of the limited time I had for writing this thesis.

Table 27 Summary table of devices, tools and methods for soil investigation.

<u>Soil investigation</u>	Can it work on Mars?	Why?	Possible problems?
Geotechnical description of soils	yes	It is a mostly visual method that doesn't require specific machinery or tools, it is very useful and good way to start soil investigation.	Some terrains might be hard to access so it would require drones and/or rovers equipped with cameras. Touching soil with bare hands during EVA is not possible because of the suit, but if taken to the base it would be.
Grain size analysis	partially	Grain size analysis is possible for bigger size particles that can be sieved.	This is not possible for clays, that would require water and other sedimentary methods.
Standard penetration test	Yes, but needs adaptation	It doesn't require water to function, mechanics in this machine can be adapted and it would require connecting it to the rover.	Different gravity affects it, results would have to be adapted since it is based on the weight of the hammer and it is a big machine so that is a big disadvantage.
Static cone penetration	Yes, but needs adaptation	It doesn't require water to function, mechanics in this machine can be adapted and it would require connecting it to the rover.	Size of this device is the biggest problem and with that transportation.

Field vane test	Yes, but needs adaptation	It is not affected by gravity and it does not require liquid water to function.	Size of this device is the biggest problem and with that transportation.
Pressuremeter test	Yes, but needs adaptation	It doesn't require liquid water to function, mechanics in this machine can be adapted.	It requires borehole to function and that is a difficult to make on Mars, also size of this device is a problem.

Table 28 Summary table of devices, tools and methods for rock investigation

<u>Rock investigation</u>	Can it work on Mars?	Why?	Possible problems?
Schmidt hammer	yes	It doesn't require liquid water to function, device is simple and easy to use. If used horizontally gravity doesn't affect it.	If used during EVA for on-site investigation it could be difficult for the astronaut to handle this device if needed on ground, so to solve that problem device can be mounted on telescopic handle, also results might have deviances because of the temperature so that needs to be taken into account when analyzing data.
Shear strength test on discontinuities	Yes, but needs adaptation		
Tilt test	yes	This test is very simple and can be conducted on site and in laboratory, also it doesn't require liquid water.	Possible problem here is that it would be difficult to conduct this test on ground it would require some higher flat surface so that astronauts doesn't have to bend much.
P-wave velocity test	yes	Device is relatively simple and mechanics inside wouldn't be affected by Martian conditions, doesn't require liquid water or specific sample preparation, they can be irregular shaped.	Temperature of the samples can affect results, also it can be used on site but it would have to be slightly adapted, since it has smaller pieces that could be difficult to handle in gloves.
Equotip	yes	Simple and small device.	Some pieces may be too small so they would have to be adapted for easier grip in gloves.
Geologist hammer	yes	Simple and small tool, already used for planetary exploration, and also in simulated missions created by the ÖWF it is contained in	Only problem here can be size of the grip, but during donning process analog astronaut dr. Thomas Wijnen successfully picked it up from

		small toolbox that is mounted to the analog suit.	one position and placed it on another.
Brazilian test	Yes, but needs adaptation	This device doesn't use liquid water and mechanics can be adapted for using on Mars	Big disadvantage of this device is his size and the fact that it needs sample preparation, they need to be shaped in very specific way and that can be a problem on Mars.
Point load test	Yes, needs adaptation	It doesn't require liquid water and samples for this test can be irregular.	This device can be dangerous for the suit or base, since sample can rupture when pressure applied and specially with irregular samples that can be a problem. If conducted it needs to be contained in chamber that will protect habitat from those small pieces.
Cerchar abrasivity test	Yes, needs adaptation	This device doesn't use liquid water and mechanics can be adapted for using on Mars	Big disadvantage of this device is his size.

7. Conclusion and Outlook

In my thesis I researched and evaluated geotechnical devices and tests for soil and rock investigation. Main goal was to compare conditions on Earth and Mars, and to think about possible problems that could occur when using in Martian conditions. Moreover, to think about space suit movement limitations and how some experiments can damage the suit and possibly endanger human. With all that it is important to think of ways to prepare those devices for Martian conditions. In order to get a better understanding of astronaut's movement possibilities I visited Austrian Space forum while they were conducting donning process. While I was compiling tables with possible problems of devices described in literature background, I got an idea to test some of them in different temperature conditions and see how that temperature change affects results.

It is a big challenge deciding what devices should be taken to Mars because there are many variables affecting that decision.

For more detailed investigation of this topic, I would say that derived parameters should be calculated, also more temperature difference experiments; like lowering the temperature of the device and not the rock sample so we can see how device would behave in different conditions and then compare it to the room temperature ones, also some experiments could be done in vacuum chamber so we can isolate pressure. More detailed research on the devices themselves should be conducted by someone who is more proficient in mechanical engineering and also materials. Studies about successfully fitting these devices into a rocket should be done.

Publication bibliography

A. P. Rossi and S. Gasselt (2010): *Geology of Mars after the first 40 years of exploration*, checked on 2/22/2021.

A. Yin (2012): An episodic slab-rollback model for the origin of the Tharsis rise on Mars: Implications for initiation of local plate subduction and final unification of a kinematically linked global plate-tectonic network on Earth. In *Lithosphere* 4 (6), pp. 553–593. DOI: 10.1130/L195.1.

A.R. Philpotts; J.J. Ague (2011): *Principles of igneous and metamorphic petrology*. 2. ed., 4. print. Cambridge: Cambridge Univ. Press.

Anon (1979): *Bull. Int. Ass. Eng. Geol. Bull.*

ASTM 1995: *Standard Test Method for Determination of the Point Load Strength Index of Rock and Application to Rock Strength Classifications*.

B.L. Ehlmann; J.F. Mustard; G.A. Swayze; R.N. Clark; J.L. Bishop; F. Poulet et al. (2009): Identification of hydrated silicate minerals on Mars using MRO-CRISM: Geologic context near Nili Fossae and implications for aqueous alteration. In *J. Geophys. Res.* 114. DOI: 10.1029/2009JE003339.

D.E. Shean (2005): Origin and evolution of a cold-based tropical mountain glacier on Mars: The Pavonis Mons fan-shaped deposit. In *J. Geophys. Res.* 110 (E5). DOI: 10.1029/2004JE002360.

D.W. Hyndman (1985): *Petrology of igneous and metamorphic rocks*. 2. ed. New York: McGraw Hill (McGraw Hill international series in the earth and planetary sciences).

E. Lakdawalla (2018a): *The Design and Engineering of Curiosity. How the Mars Rover Performs its Job*.

E. Lakdawalla (2018b): *The Design and Engineering of Curiosity. How the Mars Rover Performs Its Job*.

E. Lancelot (2010): *Raman Spectroscopy for geological materials analysis*.

G. Caravaca; S. Le Mouélic; N. Mangold; J. L'Haridon; L. Le Deit; M. Massé (2020): 3D digital outcrop model reconstruction of the Kimberley outcrop (Gale crater, Mars) and its integration into Virtual Reality for simulated geological analysis. In *Planetary and Space Science* 182, p. 104808. DOI: 10.1016/j.pss.2019.104808.

Geotechdata: Cerchar abrasivity test. Available online at <http://www.plinninger.de/images/consulting/cerchar2.jpg>, checked on 6/22/2021.

Geotechnik.com: Point load apparatus. Available online at <https://www.wille-geotechnik.com/en/portable-point-load-test-apparatus.html>, checked on 6/23/2021.

H. Blatt; R.J. Tracy (2001): *Petrology. Igneous, sedimentary, and metamorphic*. 2. ed., 5. printing. New York, NY: Freeman.

Hardwick & Sons: Estwing Rock Pick Geologist Hammer with Nylon Grip. Available online at <https://hardwickandsons.com/products/estwing-rock-pick-geologist-hammer-with-nylon-grip>, checked on 6/23/2021.

I. Smith (2014): *Smith's Elements of Soil Mechanics*.

ISRM (1978): Suggested Methods for Determining Tensile Strength of Rock Materials Part 2: Suggested Method for determining indirect tensile strength by the Brazil Test. *International Journal of Rock Mechanics and Mining Sciences*.

ISRM (1985): Suggested method for determining point load strength. *International Journal of Rock Mechanics and Mining Sciences*, pp. 51–60.

J. Rusnak and C. Mark: Using the Point Load Test to Determine the Uniaxial Compressive Strength of Coal Measure Rock.

J.L. Bishop; M.D. Lane; M.D. Dyar; A.J. Brown (2008): Reflectance and emission spectroscopy study of four groups of phyllosilicates: smectites, kaolinite-serpentines, chlorites and micas. In *Clay miner.* 43 (1), pp. 35–54. DOI: 10.1180/claymin.2008.043.1.03.

J.P. Grotzinger (2013): Analysis of surface materials by the Curiosity Mars rover. In *Science (New York, N.Y.)* 341 (6153), p. 1475. DOI: 10.1126/science.1244258.

K. Terzaghi (1943): *Theoretical Soil Mechanics*.

L. Zhang (2017): *Engineering properties of rocks. 2., rev. ed.* Amsterdam: Elsevier [u.a.].

L.I. Gonzalez de Vallejo and M. Ferrer (2011): *Geotechnical engineering*.

M.C. Malin; K.S. Edgett (2000): Sedimentary rocks of early Mars. In *Science (New York, N.Y.)* 290 (5498), pp. 1927–1937. DOI: 10.1126/science.290.5498.1927.

Mineralogy society of America, J. J. Papike, editor (1998): *Planetary materials. Reviews in Mineralogy* (36).

Morris et al. (1989, 1993): Evidence for pigmentary hematite on Mars based on optical, magnetic and Mossbauer studies of superparamagnetic (nanocrystalline) hematite.

NASA: Electrical Power. Mars Curiosity Rover. Available online at <https://mars.nasa.gov/msl/spacecraft/rover/power/#:~:text=The%20rover%20requires%20power%20to,heat%20of%20plutonium's%20radioactive%20decay>.

NASA: Mineralogy and geochemistry. Mars Pathfinder science results. Available online at <https://mars.nasa.gov/MPF/science/mineralogy.html>, checked on 8/12/2021.

NASA: Perseverance rover instruments. Available online at <https://mars.nasa.gov/mars2020/spacecraft/instruments/>.

NASA: PIA01122: Sojourner Rover Near "The Dice". Available online at <https://photojournal.jpl.nasa.gov/catalog/PIA01122>.

NASA: Rover Curiosity. Available online at <https://mars.nasa.gov/msl/mission/overview/>.

NASA: Sedimentary Mars. Available online at https://science.nasa.gov/science-news/science-at-nasa/2000/ast04dec_2, checked on 8/12/2021.

NASA: Solar system exploration. Available online at <https://solarsystem.nasa.gov/planets/earth/overview/>.

NASA (1969-1972): NASA database Apollo missions.

NASA (2020): What is Mars? Available online at <https://www.nasa.gov/>.

ÖWF: Austrian Space Forum.

P.K. Byrne (2020): A comparison of inner Solar System volcanism. In *Nat Astron* 4 (4), pp. 321–327. DOI: 10.1038/s41550-019-0944-3.

P.K. Robertson and R.G. Campanella (1983): Interpretation of cone penetration test. Part I, sand.

Particletechlabs: Sieves for particle distribution analysis. Available online at <https://www.particletechlabs.com/analytical-testing/particle-size-distribution-analyses/sieve-analysis>, checked on 6/22/2021.

Proceq: Equotip device. Available online at https://www.proceq.com/fileadmin/_processed_/d/0/csm_Equotip_Complete_Hardness_Testing_Solution_56ca684674.jpg, checked on 6/22/2021.

R. Lancellotta (1995): Geotechnical engineering.

R. Verish (2000): The Los Angeles Meteorite. Meteoritical Bulletin 84. Available online at <https://www2.jpl.nasa.gov/snc/la.html>.

R.V. Morris; G. Klingelhöfer; C. Schröder; D.S. Rodionov; A. Yen; D.W. Ming et al. (2006): Mössbauer mineralogy of rock, soil, and dust at Meridiani Planum, Mars: Opportunity's journey across sulfate-rich outcrop, basaltic sand and dust, and hematite lag deposits. In *J. Geophys. Res.* 111 (E12), n/a-n/a. DOI: 10.1029/2006JE002791.

Rampe, E. B.; Blake, D. F.; Bristow, T. F.; Ming, D. W.; Vaniman, D. T.; Morris, R. V. et al. (2020): Mineralogy and geochemistry of sedimentary rocks and eolian sediments in Gale crater, Mars: A review after six Earth years of exploration with Curiosity. In *Geochemistry* 80 (2), p. 125605. DOI: 10.1016/j.chemer.2020.125605.

S. Saptonoa, S. Kramadibrata, B. Sulistianto (2013): Using the Schmidt Hammer on Rock Mass Characteristic in Sedimentary Rock at Tutupan Coal Mine.

S. Yagiz (2011): P-wave velocity test for assessment of geotechnical properties of some rock materials. In *Bull Mater Sci* 34 (4), pp. 947–953. DOI: 10.1007/s12034-011-0220-3.

T. Warwick: Raman Spectroscopy in Geology.

W. Verwaal and A. Mulder (1993): Estimating Rock Strength with the Equotip Hardness Tester.

W.D. Nesse (2012): Introduction to mineralogy. 2nd ed. New York: Oxford University Press.

Y. Zhang; Q. Tao; S. Komarneni; J. Liu; Y. Zhou; F. Yang; B. Zhang (2021): Clay coatings on sands in the western Qaidam Basin, Tibetan Plateau, China: Implications for the Martian clay detection. In *Applied Clay Science* 205, p. 106065. DOI: 10.1016/j.clay.2021.106065.