

# Influence of layered casting and phased construction on the stressing due to self-weight

---

**Mužić, Ana**

**Master's thesis / Diplomski rad**

**2020**

*Degree Grantor / Ustanova koja je dodijelila akademski / stručni stupanj:* **University of Rijeka, Faculty of Civil Engineering / Sveučilište u Rijeci, Građevinski fakultet**

*Permanent link / Trajna poveznica:* <https://um.nsk.hr/um:nbn:hr:157:288619>

*Rights / Prava:* [In copyright](#) / [Zaštićeno autorskim pravom.](#)

*Download date / Datum preuzimanja:* **2025-03-13**



*Repository / Repozitorij:*

[Repository of the University of Rijeka, Faculty of Civil Engineering - FCERI Repository](#)



*image not found or type unknown*



Ana Mužić BSc

**Influence of layered casting and phased construction on the  
stressing due to self-weight**

**MASTER THESIS**

for obtaining the academic degree

Graduate engineer

Master Program in Civil Engineering - Structural Engineering

submitted to the

**Technischen Universität Graz and  
Građevinski fakultet u Rijeci**

Supervisor

Dirk Schlicke, Ass.Prof. Dipl.-Wirtsch.-Ing. Dr.techn.

Institut für Betonbau

and

Doc. dr. sc. Paulo Šćulac

Građevinski fakultet u Rijeci

Graz, January 2020

## Statutory declaration

### *AFFIDAVIT*

Ich erkläre an Eides statt, dass ich die vorliegende Arbeit selbstständig verfasst, andere als die angegebenen Quellen/Hilfsmittel nicht benutzt, und die den benutzten Quellen wörtlich und inhaltlich entnommenen Stellen als solche kenntlich gemacht habe. Das in TUGRAZonline hochgeladene Textdokument ist mit der vorliegenden Masterarbeit identisch.

*I declare that I have authored this thesis independently, that I have not used other than the declared sources/resources, and that I have explicitly indicated all material which has been quoted either literally or by content from the sources used. The text document uploaded to TUGRAZonline is identical to the present master's thesis.*

---

Datum / Date

---

Unterschrift / Signature

## Abstract

This master thesis deals with a detailed investigation of the influence of layered casting and phased construction on the stressing due to self-weight. The investigations are carried out with finite element analysis and in particular, the occurring stressing due to self-weight without and with regard to the casting and construction process are compared. The investigations were done for two different cases.

The first case is a massive concrete foundation which is casted in layers. Although the layers are placed fresh-in-fresh on top of each other, the casting process lasts overall that long that the lower layers developed already significant stiffness before the upper layers do even set. The investigations in this case focus therefore on the question how the resulting differences on the present stiffness over the height may cause significant changes in the horizontal stressing due to the settlement due to self-weight.

The second case is a jointless building construction with two building cores and several floors over the height. The floors are cast subsequently whereby the increasing self-weight with ongoing construction process causes a subsidence cavity in which the whole structure settles. And by this the build-up of a bending moment over the entire height of the building with a tensile force in the foundation slab is presumed.

**Keywords:** soil-structure interaction, self-weight, phased construction, layered casting, massive concrete structures, crack control, finite element method, stresses and deformations, Sofistik, numerical model

## Sažetak

Tema ovog diplomskog je istražiti utjecaje betoniranja u slojevima i fazne gradnje na naprezanja uzrokovana vlastitom težinom konstrukcija. Istraživanja su provedena analizom konačnih elemenata, a posebno su se uspoređivala naprezanja uzrokovana vlastitom težinom gdje su utjecaji prilikom betoniranja i samog procesa izgradnje uspoređeni. Ispitivanje je provedeno na dva različita slučaja.

Prvi slučaj je slučaj masivnog betonskog temelja gdje se betoniranje vrši u slojevima. Iako su slojevi lijevani jedan na drugi, cijeli proces traje sve dok donji sloj ne razvije dovoljnu krutost prije nego li se gornji sloj slegne. U fokusu ovog istraživanja je istražiti kako rezultirajuće razlike na postojećoj krutosti po visini mogu uzrokovati značajne promjene u horizontalnim naprezanjima kao posljedica slijeganja zbog vlastite težine.

Drugi slučaj predstavlja kruta okvirna konstrukcija s dvije betonske jezgre te je primjer fazne gradnje. Pretpostavka u ovom slučaju je da će moment savijanja u pločama rasti s većom visinom te da će se pritom u temeljnoj ploči javiti velika vlačna sila odnosno naprezanja.

**Ključne riječi:** interakcija tla i građevine, opterećenje od vlastite težine, fazna izgradnja, betoniranje u slojevima, masivne betonske konstrukcije, metoda konačnih elemenata, naprezanja i deformacije, Sofistik, numerički model

## **Acknowledgements**

First of all I would like to express my sincere gratitude to my supervisor, Ass. Prof. Dirk Schlicke, for accepting to be my supervisor, his patience, his help and availability every time I needed it and for leading me through my work with his knowledge, insights and comments. I would also like to thank all at TU Graz at Institute for concrete structures for giving me an office to write my master thesis and for accepting me and making me feel welcomed and like home.

Thanks to my friends and colleagues for being always here for me.

I am especially grateful to my family, my parents and my brother, for always being here for me, supporting me and believing in me throughout my student years and in my life in general. I have a big extended family and they all have also always have been here for me, so thank you.

## Content

<b>List of pictures .....</b>	<b>9</b>
<b>List of tables.....</b>	<b>11</b>
<b>1. INTRODUCTION AND MOTIVATION.....</b>	<b>12</b>
1.1 Soil-structure interaction in general .....	12
1.2 Today’s design practice in which SSI is considered .....	16
1.3 Viewed cases in this work .....	19
1.4 Relevant results.....	21
<b>2. IN GENERAL ABOUT THE APPLIED FE-SOFTWARE SOFiSTiK.....</b>	<b>23</b>
2.1 Preprocessing .....	24
2.2 Processing.....	24
2.3 Postprocessing .....	24
<b>3. FE-METHOD.....</b>	<b>26</b>
3.1 In general about the method .....	26
3.2 FE-modeling concerning the subject itself .....	29
<b>4. CASE 1: MASSIVE FOUNDATION BLOCK.....</b>	<b>31</b>
4.1 Case description.....	31
4.2 Motivation of specific models .....	32
4.3 Modelling.....	32
4.3.1 Mesh.....	33
4.3.2 Support conditions.....	35
4.3.3 Loads .....	35
4.3.4 Numerical model .....	36
4.4 Result analysis .....	38
4.4.1 Model 1: “All-in-once” without horizontal interaction.....	38
4.4.2 Model 2: “All-in-one” with horizontal interaction.....	42
4.4.3 Model 3: “Layer-by-layer” with immediate stiffness and without horizontal interaction.....	43

4.4.4	Model 4: “Layer-by-layer” with delayed stiffness and with horizontal interaction	47
4.4.5	Model 5: “Layer-by-layer” with delayed stiffness and without horizontal interaction.....	48
4.5	Discussion on Case 1 .....	54
<b>5.</b>	<b>CASE 2: 7-FLOOR BUILDING.....</b>	<b>56</b>
5.1	Case description.....	56
5.2	Motivation for behind case 2 and its model’s.....	57
5.3	Modeling.....	57
5.3.1	Mesh generation .....	57
5.3.2	Loads .....	58
5.3.3	Numerical model.....	58
5.4	Result analysis .....	60
5.4.1	Model 1: “All-in-once without horizontal interaction” .....	60
5.4.2	Model 2: “All-in-once with horizontal interaction” .....	61
5.4.3	Model 3: “Phased construction with horizontal interaction” .....	62
5.4.4	Model 4: “Phased construction without horizontal interaction” .....	63
5.5	Discussion on Case 2 .....	66
<b>6.</b>	<b>CONCLUSION .....</b>	<b>71</b>
	<b>LITERATURE LIST .....</b>	<b>73</b>



## Symbols

### Big Latin letters

B	Width of concrete block
E	Elastic modulus
F	Actions
H	Height of concrete block
L	Length of concrete block
X	Material properties
HL	Height of one layer
LS	Length of soil body
WS	Width of soil body
DS	Thickness of soil body

### Small Latin letters

a	Geometric data
k	Stiffness
$t_{\text{base}}$	Thickness of a base slab
$t_{\text{slab}}$	Thickness of a slab
$t_{\text{core}}$	Core thickness
$b_{\text{col}}$	Column dimensions

### Indeks

i	index of z direction
j	index of y direction
k	index of z direction

x	x direction
y	y direction
z	z direction

## List of abbreviations

AQUA	Materials and Cross Sections
ASE	General Static Analysis of Finite Element Structures
BEMESS	Design of reinforced concrete/area elements
BORE	Soil or bore profile
BRIC	Three-dimensional solid elements
EC	Eurocode
FE	Finite elements
FEM	Finite element method
HASE	Halfspace definition
SIR	Sectional results
SOFIMSHA	Import and export of finite elements and beam structures
SSI	Soil-structure interaction
TRAN	Transformations

## List of pictures

Figure 1: Winkler's model [12] .....	14
Figure 2: Hoover dam [4] .....	17
Figure 3: Sketch of the situation and view of the bridge [14] .....	18
Figure 4: Case 1 .....	19
Figure 5: Case 2 .....	20
Figure 6: Normal stress at bending with transversal forces.....	21
Figure 7: Sofistik data base [2].....	23
Figure 8: Finite elements for the first three problems [9].....	26
Figure 9: Dimensions of the beam and different divisions into the elements [1].....	27
Figure 10: Example of triangles mesh discretization [1].....	29
Figure 11: Illustration of case 1 .....	31
Figure 12: Mesh fineness.....	34
Figure 13: BRIC solid elements [10].....	36
Figure 14: Couplings between concrete body and soil [7] .....	38
Figure 15: Nodal displacements in contact area in z-direction for model 1 in mm .....	39
Figure 16: Case 1 – Distribution of stresses in global x-direction .....	40
Figure 17: Model 1 – 3D stresses in global x-direction at the symmetry face of the block in MPa.....	41
Figure 18: Model 2 – 3D stresses in global x-direction at the symmetry face of the block in MPa.....	42
Figure 19: Model 3 – 3D stresses in global x-direction at the symmetry face of the block in MPa.....	43
Figure 20: Model 4 – 3D stresses in global x-direction at the symmetry face of the block in MPa.....	48
Figure 21: Model 5 – 3D stresses in global x-direction at the symmetry face of the block in MPa.....	49
Figure 22: Ilustration of case 2 .....	56
Figure 23: List of groups [11] .....	59
Figure 24: Model 1 - Horizontal stresses in MPa.....	61
Figure 25: Model 2 - Horizontal stresses in MPa.....	62
Figure 26: Horizontal stresses in MPa.....	63

Figure 27: Model 4 - Horizontal stresses in MPa.....	64
Figure 28: Membrane force in ground slab in local x-direction in kN/m.....	64
Figure 29: Nodal displacement in ground slab in global z-direction in mm.....	65
Figure 30: Graph showing the results of parametric study.....	70

## List of tables

Table 1: Technical characteristics of Hoover dam [6] .....	17
Table 2: Results of observation point A in different cases.....	28
Table 3: Model 3 – stress distribution layer-by-layer .....	44
Table 4: Model 5 – stress distribution ”layer-by-layer” with delayed stiffness and without horizontal interaction.....	50
Table 5: Overall of all five cases .....	54
Table 6: Reinforcement design for ground slab in cm <sup>2</sup> /m.....	66
Table 7: Top stresses in x-direction in MPa.....	67
Table 8: Parametric study .....	68

# 1. INTRODUCTION AND MOTIVATION

The aim of this Master thesis was to investigate very specific aspect of soil-structure interaction using finite element method. The structures under which this influence was studied are large-scale structures.

One may ask “Why exactly are such structures in focus?” and the answer is that there is a growing need for such buildings of different purposes. Of course, today we are already witnessing many of these structures, but there is still a lot that we don’t know about their behavior and influence. As more structures like this will be built in the future, my motivation was to give further insight and discussion basis for design tasks where different aspects may become decisive.

## 1.1 Soil-structure interaction in general

Soil–structure interaction is an interdisciplinary field of endeavor which lies at the intersection of soil and structural mechanics, soil and structural dynamics, earthquake engineering, geophysics and geomechanics, material science, computational and numerical methods, and diverse other technical disciplines [1]. Over the past, numerous scientists and engineers have tried to describe the interaction between the soil and the structure creating different models and using different assumptions. French mathematicians Gabriel Lamé and Benoît Paul Émile Clapeyron were the first scientists to address the problem of loads on or within an infinite elastic body. Unfortunately, they failed in obtaining any useful results in order to solve the half-space problem, but that moment became a turning point in addressing the issue. After few years one scientists named Joseph Valentin Boussinesq first mentioned vertical point loads applied onto the surface of an elastic half-space, while more than 20 years later Sir Horace Lamb constitutes the modern integral transform method to obtain the response to either impulsive (2-D) or suddenly applied (3-D) vertical loads on the surface of an elastic half-space [1]. In that time Lamb didn’t have today’s tools to solve such complex integrals so his work for a while stayed unfinished. Many other scientists also contributed to today's knowledge of soil behavior, while Austrian engineer Karl Terzaghi is referred today as father of soil mechanics.

Thanks to this rich history, today there are several assumptions for calculating the stress distribution in the ground below the structure, specially, soil models:

- i. The foundation transfers the load with linear stress distribution on the soil
- ii. The soil is replaced with a model of elastic springs in which the deformations are proportional to the forces that are acting on them (Winkler model)
- iii. The soil is elastic half-space (Boussinesq soil model)
- iv. The soil is compressible, inhomogeneous layered space

When choosing a soil model, it is first decided on the basis of the strength of the soil whether the foundations will be shallow or deep . The second criteria concerning shallow foundations is weather the foundation structure will be rigid or elastic. For rigid foundation structures the stress distribution is generally linear while for elastic foundation structures that is not the case. The classification criteria for the type of foundation structure is defined by Regulatory Technical Standards:

$$K = \frac{E_b}{12E_s} \left(\frac{d}{L}\right)^3 \quad (1)$$

where:  $E_b$  – girder modulus of elasticity

$E_s$  – soil modulus of elasticity

$d$  – girder height

$L$  – girder length

Based on expression (1) the division criterion is.

$$K > 0,4 \rightarrow \text{rigid foundation} \quad (2)$$

$$K < 0,4 \rightarrow \text{elastic foundation} \quad (3)$$

Two of well-known soil models are Winkler's and Boussinesq's models of soil. Winkler's idealization (Figure 1) replaces the soil with identical mutually independent, but closely spaced linear elastic springs. Due to mutual independence, deformation occurs only in those springs below the loaded region. This model is representing an elastic soil and it is used for its simplicity. The main problem of this model is to determine the stiffness of elastic springs used to replace the soil below foundation.

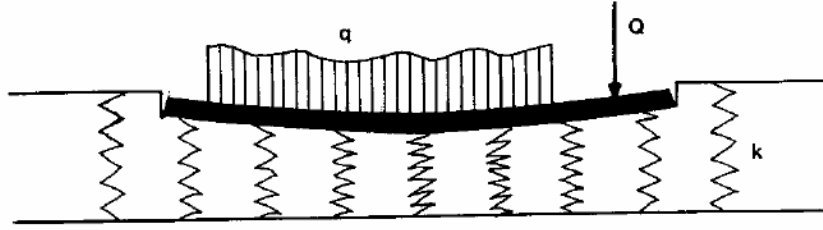

Figure 1: Winkler's model [12]

Boussinesq's model interprets the soil-structure behavior closer to reality because it is derived from a model of elastic half-space in which any load on the surface of the half-space causes the settlement in all areas of half-space. For each point, the settlement is calculated from the load magnitude on the ground of the overall girder. The finite element method is needed while the differential equation can't be solved analytically but by discretization of finite elements.

One thing in common to all soil models is deformation. When a soil is loaded by a structure the result is settlement in the ground. The question is how much settlement will occur and how fast will it occur. Settlements always occur for all types of structures and it is normal if they are within the permitted limits. In the moment when they exceeded the allowed limit, structural as well as other damage may occur especially if such settlement occurs rapidly [13]. For this reason, it is important to take into account all the components of settlement. Total settlement ( $s_t$ ) constitutes of the immediate settlement ( $s_i$ ), the consolidation settlement ( $s_c$ ) and the secondary compression ( $s_s$ ) (4).

$$s_t = s_i + s_c + s_s \quad (4)$$

The immediate settlement occurs in short time after applying the load and it is computed by elastic theory. Depending on the soil the size of immediate settlement varies. In saturated clay the settlement will take place under constant volume while there won't be enough time for soil mass to change its water content. The consequence is very small immediate settlement comparing to consolidation settlement. If the soil is coarse-grained it has a high permeability so the water and air will be able to escape very rapidly while compressing the soil. In this case the immediate settlement can't be ignored. Unlike immediate settlement, consolidation settlement is time dependent. It occurs in saturated fine-grained soils that have a low coefficient of permeability. The rate of settlement depends on the rate of pore water



drainage [13]. The last component is secondary settlement that is also time-dependent and it occurs at constant effective stress.

But the structures sometimes don't settle as a whole, which means there are differences between various areas. This is called non-uniform settlement and it a reason why there are damages on the structures. Depending on the use of the structure, the maximum total settlement can vary considerably even if two same structures are built right next to each other.

One of the results obtained by software is the final settlement of analyzed structure and it is important to engineers to check if the structure is dimensioned well so that settlements aren't too big. This means that from the start the structures are oversized. Another advantage is that many softwares can simulate places of possible fractures whereby analyzing them and adjusting the model accordingly those fractures can be prevented.

Settlements and possible fractures do not only depend on type and characteristics of the structure but also on the characteristics of the soil. The weaker the soil is the deeper the foundations must be until the firmer soil is reached. Weak soils can also be strengthened but it depends on the type of structure, use of the structure and characteristics of strengthened soil if those measures will be taken. Weak soils deform more and much faster, so the type of soil plays a big role in calculating a structure. If the soil for any reason, for example due to the earthquake, weakens it means it does not have the sufficient strength anymore which is needed and the stresses in structure increase sufficiently. If the soil is weakened, but the load is the same which is the case, then the stresses in the soil becomes bigger. This usually results in fractures due to the settlements.

Soil compressibility is the reason why settlements even occur. When a soil is loaded, it will compress because of [13]:

- i. deformation of soil grains
- ii. compression of air and water in the voids
- iii. squeezing out the water and air from the voids

Depending on the type of the soil it depends to which extend the compression will happen.

Along with settlements, a big factor in soil-structure interaction is allowable stress on the ground. If this value is exceeded the soil failure occurs which means that the soil wasn't able

to absorb additional stresses. Failure stress depends on soil strength parameters (cohesion of soil and angle of friction), footing dimensions, depth of foundation, level of ground water and size of horizontal force [14].

One of the repercussions of this interaction are the cracks. Cracks are caused by strains not considered in the design or calculation errors that led to the wrong strain values. Cracks usually happen in the slabs, beams and/or columns but they can appear actually anywhere, and in general on surface of the structure. A crack is considered an opening up to 5 millimeters wide. They can remain stable or grow over time. If they grow, they became deeper openings and in case they grow to be wider than 1,5 mm they are called fissures. Depending on its size they can even sometimes imply on a structural problem.

## **1.2 Today's design practice in which SSI is considered**

Today, all the different influences on the structure as wind, snow, earthquakes along with all the others, are analyzed in detail as well as their impact on construction. As the self-weight is regarded, its influence is not adequately explored. Even though today the structures that are being build are more massive then they were before, the self-weight continues to be taken into account in the same way, that is, it is calculated directly by software based on the geometry and command "self-weight = 1". In this way the whole mass of the structure is considered as it acts at the same time, not taking into account the construction phases or layered casting. For small structures this is correct enough and it does not have any or maybe just some small impact on the stresses, specifically, on the interaction between the soil and the structure. For big structures with a big mass, the impact of self-weight should be analyzed in more detail, and construction phases or/and layered casting should be considered too, while they too have a major impact on large structures.

For the topic and the problem that will be analyzed in this thesis, relevant are big concrete structures. Structures that have very big self-weight. These structures behave differently than structures with smaller self-weight because their big mass creates bigger stresses in the very structure but also additional stresses in the ground. In these structures big impact also has thermomechanical behavior but that was not the focus of this work. Some of the relevant structures are big concrete bridges, dams or even big concrete foundations for some structures.

One of the most famous is Hoover dam shown in Figure 2.



*Figure 2: Hoover dam [4]*

Hoover dam was built in 1936 and it was the largest dam of its time. The dam is concrete thick-arch structure and the soil on which it stands was extremely adverse. In Table 1 the main technical characteristics of the dam are shown.

*Table 1: Technical characteristics of Hoover dam [6]*

Dam type	Concrete thick arch
Watercourse	Colorado river
Reservoir	Lake Mead
Construction period	1931-1936
Structural height	221,3 m
Crest length	379,2 m
Crest width	13,7 m
Base width	201,2 m
Concrete volume used	3 364 041 m <sup>3</sup>

The dam wasn't built as a single block but as a series of individual columns. The reason for it is that because of its overall dimensions after pouring the concrete the concrete would have gotten really hot and it would take a lot of time in order for that heat to dissipate. Besides,

the resulting stresses would have caused the dam to crack and crumble away [6]. In this way the additional stresses that would appear if the concrete was poured all in once, because of its enormous weight, were prevented. The cooling coils were put in each column and after the concrete was poured the water from the river was released to circulate through these coils. After the initial cooling the water was released again in order to finish the cooling process after which the coils were cut, and the pressure grout was injected with pneumatic grout guns. In order to make a monolithic structure the upstream and downstream faces of each column were formed. They had vertical interlocking grooves in which, after the concrete cooled off, the grout was injected. In this way the hairline fissures between the blocks were prevented from weakening the dam.

Another example in which adequate consideration of SSI is of importance is given with massive foundation blocks, as e.g. the foundations of the Botlek Bridge in The Netherlands. Some brief details and explanations about this case are according to article “Crack assessment of a very thick and block-like concrete member”.

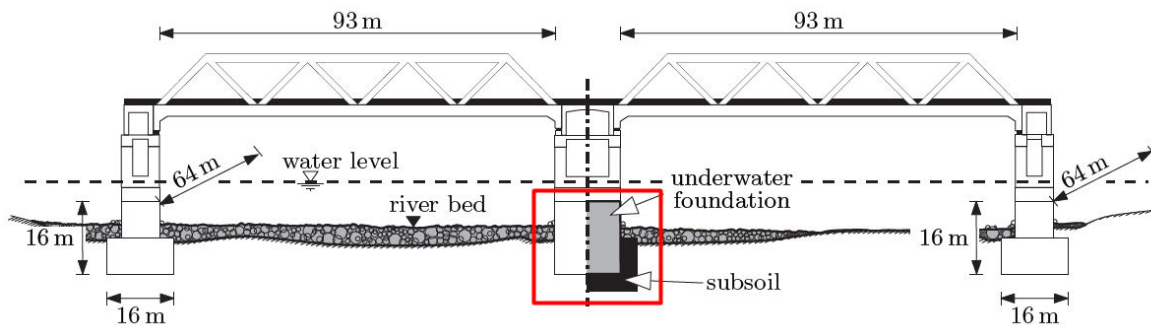

Figure 3: Sketch of the situation and view of the bridge [14]

Figure 3 shows the sketch of a bridge with a special indication of a middle foundation block which was the subject of the above-mentioned article. The block is completely submerged in water, while the lower half is at the same time buried into the subsoil. With its dimensions,  $L/H/B = 64/16/16$  meters, the block used in calculation has similar dimensions as a Botlek bridge foundation block. Research topic is on the hardening-induced stresses and the risk of cracking with the concrete hydration is taken into account. Even though the hydration is not the subject of this master thesis, even here the soil-structure interaction played a role in the obtained stresses in a block. The block has a high axial stiffness due to its large cross section compared to the ground. For this reason, the degree of external restraint is very low while the temperature gradients with regard to height, width and length are internally

restrained by the deformation compatibility within the block [14]. This difference causes distinct eigenstresses which can lead to cracks on the surface.

### 1.3 Viewed cases in this work

Two very different types of structures were modeled creating two different cases in order to investigate the soil-structure interaction in both. Particular attention was given to modeling each case and the various model options for each case. In different models of each cases the different parameters were include or exclude.

The first case is a massive block that represents a big foundation. The soil on which the block is laid is modeled as a 3D soil-body. To study the results more accurately only one fourth of the model was analyzed while using the support conditions the other three sides were described in order to take their effects on behavior into account. This structure is shown on Figure 4.

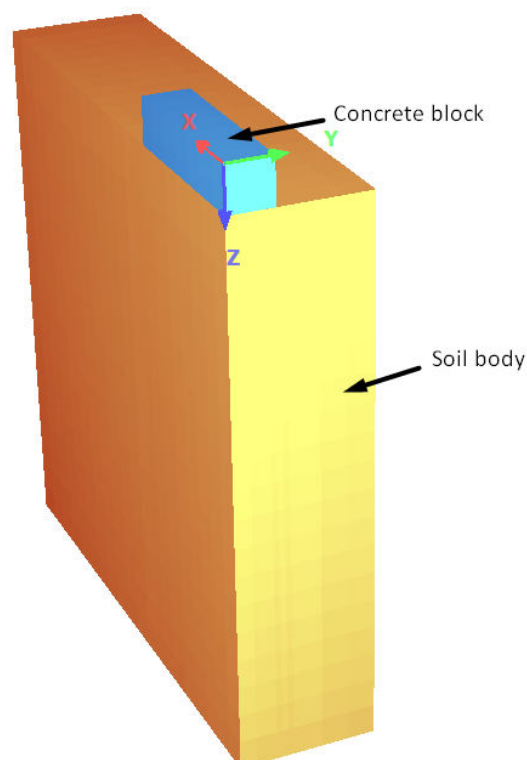

Figure 4: Case 1

In this case, 5 different combinations of parameters were considered forming 5 models:

- 1) All-in-once without horizontal interaction
- 2) All-in-once with horizontal interaction
- 3) Layer-by-layer with immediate stiffness and without horizontal interaction
- 4) Layer-by-layer with delayed stiffness and with horizontal interaction
- 5) Layer-by-layer with delayed stiffness and without horizontal interaction

First two models are taking the self-weight as the foundation is casted at once while the layerwise casting, which corresponds reality, is taken into account in the remaining models.

The second case is a structure shown on Figure 5. The building consists of slabs, columns and two cores. It can represent an office building, residential building or with some modifications, also a parking garage and a shopping center. It is an example of phased construction structure. In this case the soil is represented as a half-space.

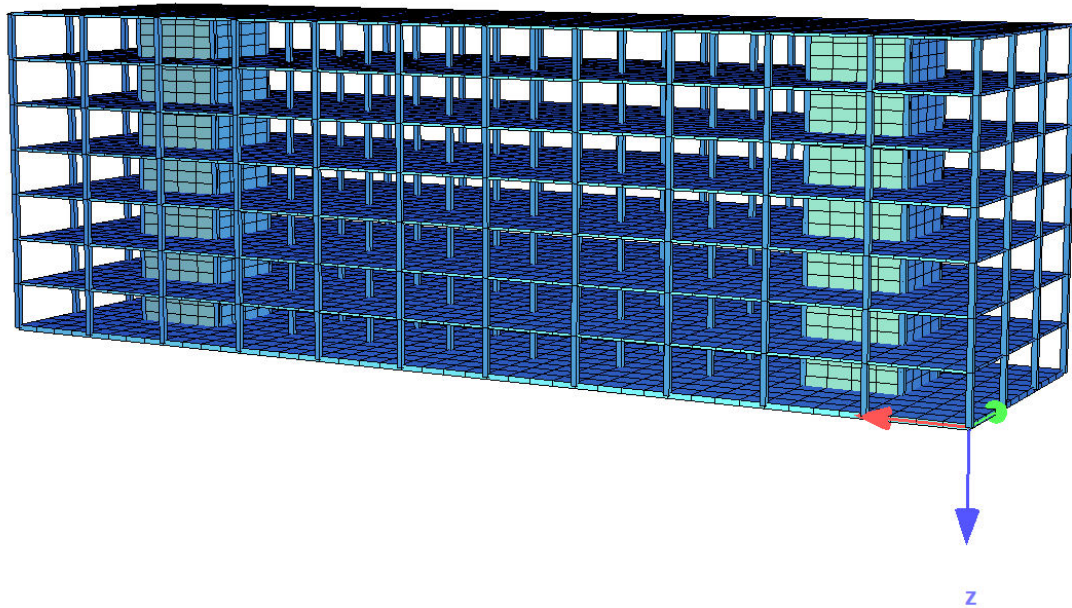

*Figure 5: Case 2*

Models that are considered in this case are:

- 1) All-in-once without horizontal interaction
- 2) All-in-once with horizontal interaction
- 3) Phased construction regarding stiffness evolution with horizontal interaction
- 4) Phased construction regarding stiffness evolution without horizontal interaction

## 1.4 Relevant results

The most important results for the two models that were studied are normal stress ( $\sigma_x$ ) and bending moment ( $M_y$ ). Normal stresses can occur at pure bending or bending with transversal forces. Structure loaded with self-weight corresponds the second case because self-weight acts as continuous load ( $q$ ). Looking at the example of simple beam loaded with continuous load it is shown how the bending moment affects normal stresses and how are they connected to each other. (Figure 6)

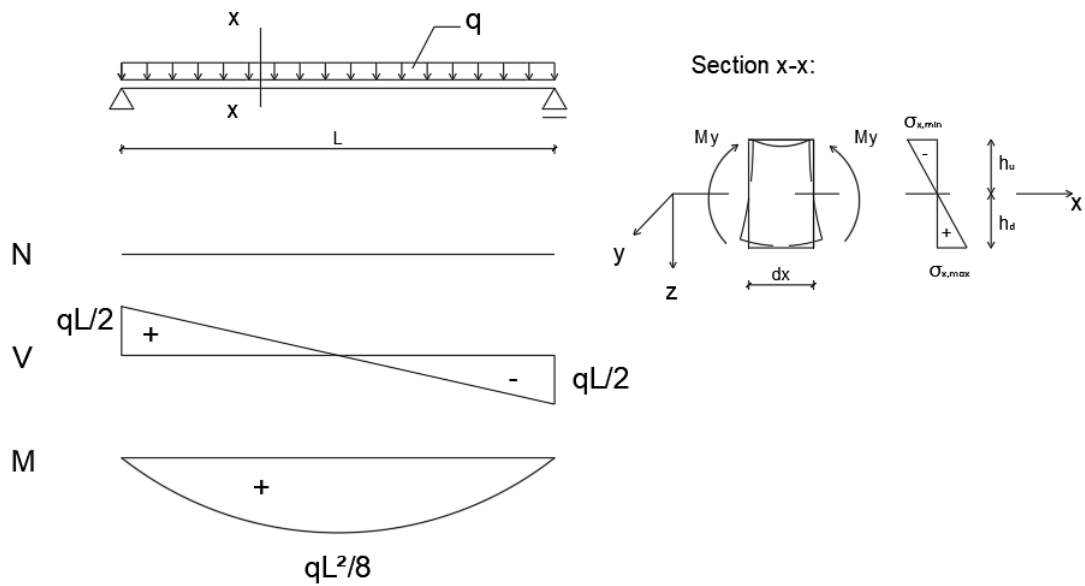

Figure 6: Normal stress at bending with transversal forces

Section x-x shows moment action on a beam caused by continuous load. As a result of this action the normal stress occurs in the beam. If the bending occurs, like in this example, in y-direction than the stresses occur in x-direction. The stress diagram is linear with opposite indications depending whether it is the compressive or the tensile stress.

$$\sigma_x = \frac{M_y}{I_y} * Z \quad \left[ \frac{N}{m^2} \right] \quad (5)$$

Equation (5) shows the general equation for normal stress. If the general equation is extended depending on the type of stress equations (6) and (7) are obtained:

$$\sigma_{x,max} = \frac{M_y}{I_y} * Z_{max} = \frac{M_y}{I_y} * h_d = \frac{M_y}{W_y * h_d} \quad \left[ \frac{N}{m^2} \right] \quad (6)$$

$$\sigma_{x,min} = \frac{M_y}{I_y} * Z_{min} = \frac{M_y}{I_y} * h_u = \frac{M_y}{W_y * h_u} \quad \left[ \frac{N}{m^2} \right] \quad (7)$$

From material resistance it is known that moment of inertia ( $I_y$ ) depends on cross-section dimensions. That means that for bigger cross-section the normal stress is smaller if the moment remains the same. The value of normal stress in some structure or in one of its elements should always be smaller than allowed value of the normal stress for it as it is shown in equations (8) and (9).

$$\sigma_{x,max} \leq \sigma_{allowed} \quad (8)$$

$$|\sigma_{x,min}| \leq \sigma_{allowed} \quad (9)$$

In WINGRAF the diagrams for 3D stresses were taken and studied for all cases, as well as the nodal displacement to see the effects of settlement. For the second case the important results were also reinforcement design values which were also taken from the program WINGRAF.



## 2. IN GENERAL ABOUT THE APPLIED FE-SOFTWARE SOFiSTiK

In this Master thesis the FE-software SOFiSTiK was used for modeling and analyzing the results. In order to have a better picture of the software and the way it works the main principles will be explained in this chapter.

Sofistik is Europe's leading Finite Element software in the construction industry [2].

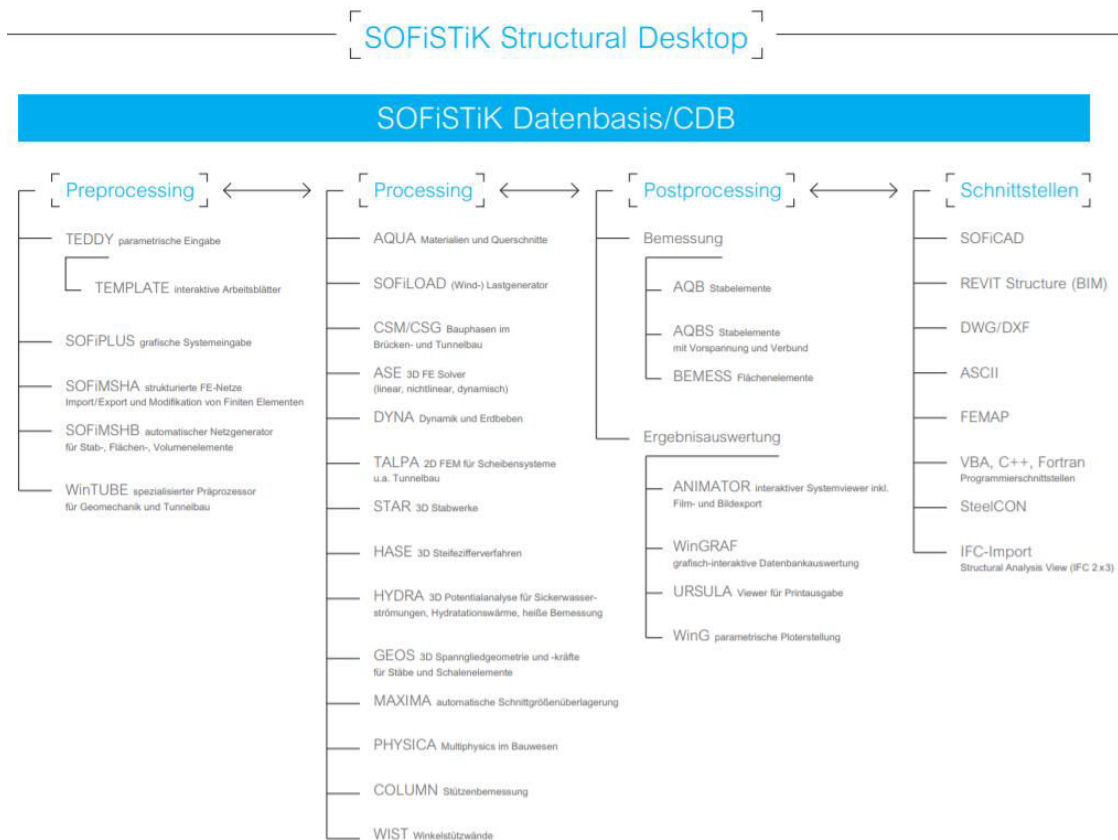

Figure 7: Sofistik data base [2]

As it is shown in Figure 7, modeling in software Sofistik consists of 3 parts/stages:

1. Preprocessing
2. Processing
3. Postprocessing

## 2.1 Preprocessing

Sofistik is offering its customers two different interfaces and procedures for modeling.

One option is to use graphical interface called SofiPlus. Using SofiPlus it is possible to choose between three interfaces, AutoCAD, Revit or Rhinoceros. The other option is script-based modelling using the programming language CADINP. The SOFiSTiK interface for scripting is called Teddy, however, any text editor could be used instead, as well. Both options have advantages and disadvantages. In general, graphical modelling is more illustrative and enables a fast model creation with respect to a high grade on detailing, whereas script-based modelling enables parametrical models. In this master thesis the script-based parametrical modelling was applied by using the interface Teddy.

Besides creating basic geometry, in this stage, it is also necessary to create a mesh for the model. For creating a mesh programs Sofimsha, Sofimshb and/or Sofimshc can be used. There are some slight differences between these programs so choosing one depends on what wants to be done with model.

The mesh itself can be done automatically by choosing some set properties or it can be arbitrary.

## 2.2 Processing

After creating the geometry of a model and a mesh the next step is to define the materials, the loads that are acting on the model and their combinations. This can be done within one of the following sections: Aqua, Sofiloat, Ase and Maxima.

Except the above-mentioned data others can also be defined in this section but since they weren't used in this master thesis they are not mentioned here.

## 2.3 Postprocessing

As part of postprocessing, FE-results are prepared for further analysis and final dimensioning is being done on basis of the results. Dimensioning is done by programs called AQB, AQBS and/or BEMESS. AQB is used for stress analysis and design of cross sections created with

AQUA while AQBS is used for some extra specific features and prestressed concrete structures. This means, AQB is used for 1D-elements like beams as well as integrated results of cross sections consisting of 2D- or 3D-elements. The program BEMESS is used for the dimensioning of 2D-elements.

Through program SIR it is possible to get the representation of the intersected elements and the graphical representation of their results as well as the resultant forces and moments including the support reactions [8]. Results can also be seen directly from WINGRAF – program for graphical representation. Through it all, the information saved in the central database can be seen. In it, it is also possible to make a SIR-cut and see wanted results for chosen intersection.

Results can be also seen with ANIMATOR or/and Result Report, Result viewer or even by accessing the database directly.

### 3. FE-METHOD

#### 3.1 In general about the method

Finite element method (FEM) is a numerical method based on the physical discretization of a model. The considered continuum with infinite degrees of freedom is replaced with a discrete model of interconnected elements with a limited number of degrees of freedom. This means that the considered continuum with the infinite degrees of freedom of movement is replaced by a discrete model of interconnected elements with a limited number of degrees of freedom [5]. The method started to develop in 1950-is and by 1960-is the term FEM has begun to be used.

The first step of FEM is to discretize a model. Depending on the shape and unknown parameters in the nodes, there are different types of finite elements. The simplest finite elements are the ones for one-dimensional problems. To solve those problems the rod and beam elements should be used. For two-dimensional problems the model is subdivided either into a number of triangles or rectangles while for the three-dimensional problems the elements with three displacement components in the Cartesian coordinate system should be used. For more complex problems there are other finite elements to use. On Figure 8 the listed finite elements are shown.

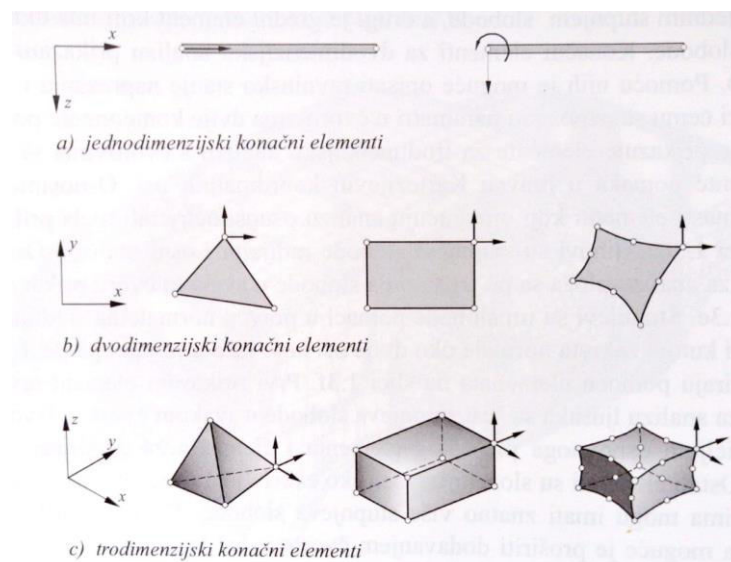
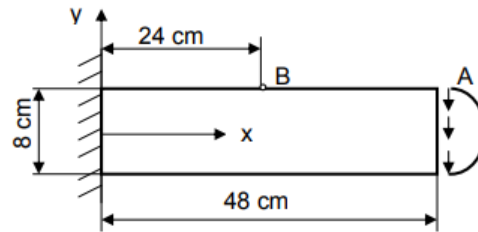
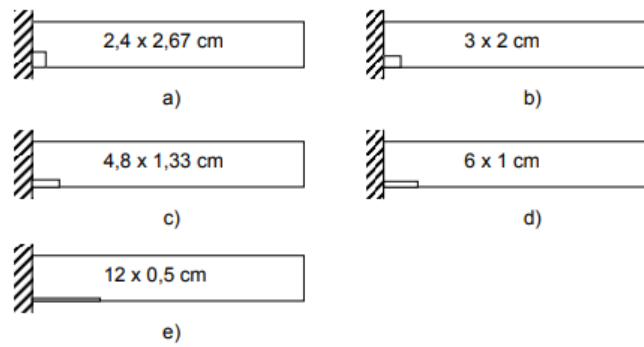

Figure 8: Finite elements for the first three problems [9]

The results of stress-deformation state directly depend on the size of the elements, the way of dividing the structure into the elements and the type of elements. Cubical elements such as in case 1 must have the appropriate ratio (relationship/relation) between length and width of the edges because considering this, the results will be less or more accurate. Figure 9 and table 2 show one example, 2D problem, of how the size of the item's distribution depends on the results.



Beam loaded with parabolic load



Different dimensions relationships

Figure 9: Dimensions of the beam and different divisions into the elements [1]

On Figure 9 five different divisions are shown. Some of the divisions have a big difference in edge ratio. This directly affects the results that are shown in Table 2.

Table 2: Results of observation point A in different cases

Case		Number of nods	Number of elements	Point A	% of error in observations
a	1.1	84	60	-1.093	5.2
b	1.5	85	64	-1.078	6.4
c	3.6	77	60	-1.014	11.9
d	6.0	81	64	-0.886	23.0
e	24.0	85	64	-0.500	56.0
Correct solution				-1.152	-

Table 2 show's that in this example the smallest % of error is in case "a" when the edge ratio is the smallest.

There are two possible ways for generating the mesh, one is done directly by software which enables automatic generation of a mesh on already created model with one of the modules. This is the most used way today because of the complexity of the models. Except automatic generation, it is also possible to generate your own mesh.

If the mesh is done arbitrarily, once when the problem is defined, and the finite elements are chosen, elements size should be determined. The edge ratio should not be big because with higher ratio the results are less accurate. If the model has some sharp regions, then the elements in this section should be smaller for results to be more accurate. All these elements are linked in nodes. Each element is considered separately as well as its features such as displacement, deformations, stresses... These features must meet the appropriate conditions so that the discretized model describes the behavior of the continuous system as accurately as it can. For each element equations are performed individually, and when the equations of all elements converge closely, then the global equation can be performed. After executing the equations for the finite elements, where unknowns are independent variables in nodes, the corresponding procedures are performed with global equations for discretized model. Using calculated node sizes, it is possible by applying known theoretical relation to determine all the sizes required for the analysis of the described continuous system.

On Figure 10 is one example of an irregular shape and its mesh discretization with triangle elements. Every triangle is indexed as well as all its corners (nodes).

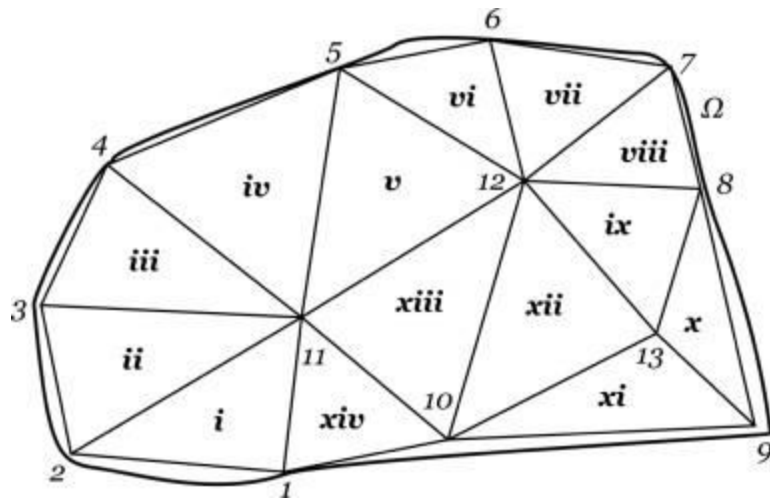

Figure 10: Example of triangles mesh discretization [1]

Defining elements and corners is needed in order to be able to do an index matrix. The finite element method is used to transform partial differential equations into a system of linear equations that can be written in matrix formulation and then calculated.

This method does not give the exact results, but they are precise enough so that they can still be used in engineering practice. Today this method is most commonly used method in numerical analysis. Thanks to its development, today we can analyze complex structures that require the discretization of a large number of elements which means that the equations have a large number of variables, which is without the computer and software more difficult to solve. FEM can be used to solve elastic problems, thermal or fluid problems and many others in civil engineering as well as problems in aeronautical engineering and other branches of engineering.

### 3.2 FE-modeling concerning the subject itself

Depending on structure type there are different finite elements used to describe them. In case one, the structure is a massive block which means it's a volumetric problem. Volumetric problems are 3D problems and therefore 3D finite elements were used is shape of parallelepiped. In these elements, the degrees of freedom are three components of movement in cartesian coordinate system and in order to have high result accuracy more degrees of freedom are required than in simpler problems. Total number is  $3n^3$  where 3 represents

degrees of freedom and  $n^3$  number of nodes. To evaluate the state of stress all six components of stress must be determined. In conclusion, the volumetric problem is very complex and it has a large number of variables in global finite element equation so the time needed to solve it it's longer.

The second case is a structure that consists of slabs and columns, therefore the elements used to describe them are 2D and 1D finite elements. 1D elements are the simplest finite elements and in this structure they are used to describe vertical columns that are loaded along the vertical axis. All the variables are in function of the z-coordinate and have only two nodes. Finite elements used for slabs in x-y direction and slabs in x-z and y-z direction forming cores are rectangular 2D elements with nodes in all four vertices. Two dimensional elements are used to solve plane stress state and plane strain in which the displacement function is most commonly displayed in the Cartesian coordinate system.



## 4. CASE 1: MASSIVE FOUNDATION BLOCK

### 4.1 Case description

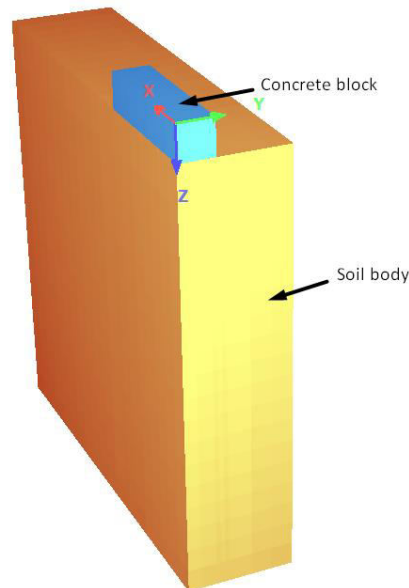

*Figure 11: Illustration of case 1*

As it is already said, this case represents a massive concrete block. In order to analyze it the basic model consists of two parts as it is shown on the Figure 11. Concrete body is solid and it is colored in blue. The second body colored in yellow is soil. The reason why soil was modeled as 3D element is to have a better illustration of results. The only problem is that it has homogeneous stiffness in all directions, but the horizontal interaction is controlled with gap between this two elements and in this way this problem was solved. Material used for concrete body was C 30/37 with secant modulus of elasticity of 32 000 MPa and for soil a new material was created with elastic modulus of 25 MPa. These two parts represent one fourth of the whole model. Concrete body has dimensions  $B \times L \times H$ , respectively 16 x 64 x 16 meters and along the height it is divided into 16 layers. The height of one layer is 1 m and the layers represent stages of construction, more precisely, pouring concrete in layers fresh-in-fresh. The bottom layer of concrete develops significant stiffness before the upper layer does not even set . The dimensions of the soil body are taken as dimensions of concrete body multiplied by 3, except for the height where the dimension is the same as lengthwise, which

means 48 x 192 x 192 meters. As the main goal is to see the interaction between concrete body and soil, the height of the soil had to be increased. Having bigger height also assures that all the deformations that occur in soil during and after inflicting the self-weight layer by layer while building a concrete body will be seen.

## 4.2 Motivation of specific models

For this case, 5 models were modeled. The aim was to see if and in what extent different approaches influence the soil-structure interaction, the stresses at the bottom of the block as well as the risk of cracking. First, the construction process was taken into account, while today the block and its self-weight is modeled in a way as it acts all-in-once and as so this influence from self-weight is taken into account during analysis. In reality this block is formed in a way that the concrete is poured in layers. Since the soil was modeled as 3D element which means it has homogenous stiffness in all directions in order to control the horizontal interaction the gap of 1 cm was created between the block and the soil. In this way the actual state between the two is considered. Third aspect that was considered is the delay in forming the stiffness of a layer. When the concrete is first poured it has a mass but almost no stiffness, the stiffness is in function of time. Having all this in mind different combinations were made.

The “skeleton” of all 5 models is the same, only the parameters important for each model were altered so that they represent wanted situation.

## 4.3 Modelling

This subchapter describes the modeling process in SOFiSTiK from start to the end. It includes the details on how the mesh was generated, what and where are the support conditions, explanation for the load as well as numerical model particulars.

### 4.3.1 Mesh

The mesh was created arbitrarily.

First step for creating the mesh was to define how many different mesh finenesses there will be. The mesh fineness are actually finite elements of different sizes for each section. The mesh consists of following:

- a) Coarse=10
- b) Rough=6
- c) Fine=1
- d) Very fine=0.5

The only difference between this four is in centimeters between two elements, that is, the size of the elements in each section.

Second step is to define the nodes in which the division (mesh fineness) changes. After doing these the model has four different sections with different divisions depending on wanted accuracy for that section.

The concrete body in x-direction has 2 sections. First section is from zero to 56 meters and the mesh fineness in this section is coarse. Next section is from 56 meters up to 64 meters, that is till the end of the concrete body. In this section the mesh fineness is fine. As for the soil, it has four sections. First two sections are the same as for the concrete body. The third section also has fine mesh fineness, as the second section, and it is from 64 meters up to 72 meters. The last sections is from 72 meters until the end, that is 192 meters, and its fineness is coarse.

In y-direction the concrete body and the soil have the same number of sections as in the x-direction, but the nodes of division and mesh fineness are different. From zero to 12 meters the mesh is rough. From 12 meters to 16 meters it is fine. The same is valid for both, the concrete body and the soil. Further, the soil has 2 more sections. The next one is from 16 meters until 20 meters with fine mesh division. In the last 28 meters the mesh division is coarse.

Z-direction has 3 sections. The whole concrete body is one section. In this section the mesh is very fine. Next two sections are for the soil. From 16 until 24 meters mesh fineness is fine and the rest to the end is the third section with coarse mesh.

After the application of the mesh fineness some sections are not exactly divided as wanted. This is due to the geometry of the model, more precisely because that section can't be divided by number that was set for mesh fineness so the last element is not a whole number but rather decimal number. In order to manage the results and to know exactly how they were gotten it was necessary to create a loop in teddy saying that all divided elements in particular section need to have the same and round value for the spacing between elements. As a result some elements have different width from the ones set with mesh fineness.

Described mesh of the model can be seen in Figure 12.

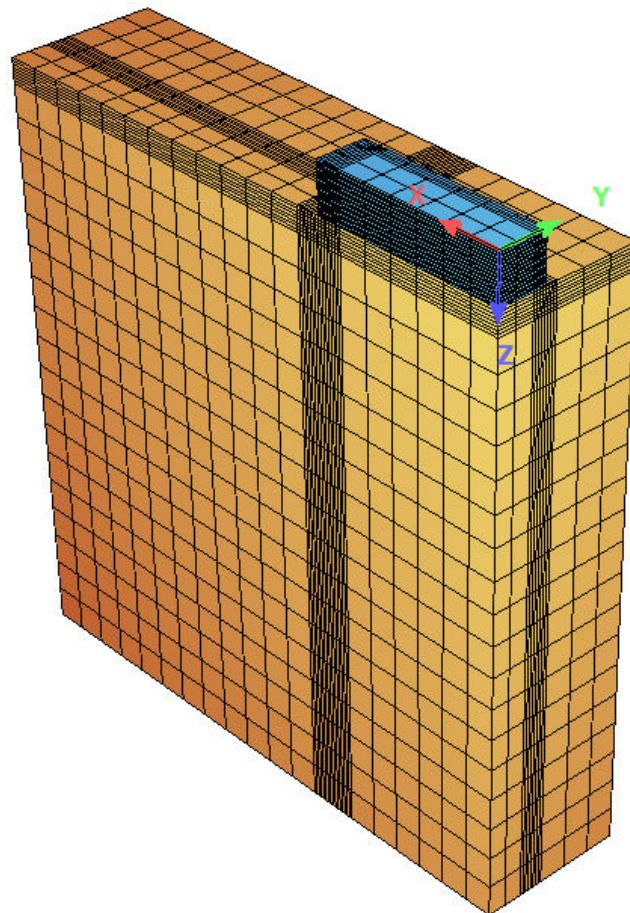

*Figure 12: Mesh fineness*

The last step in creating a mesh is to create the nodes in places where all the divided elements cross (for all three main direction combinations, x-y, y-z and z-x).

### *4.3.2 Support conditions*

Since the whole model is simplified, in order to imitate the actual state in the environment, the support conditions are needed.

On the concrete structure the support conditions are only on two sides, the sides that were “cut” in order for the model to represent one fourth of the whole model so that the results in the middle of the structure can be seen and studied better given the assumption that the stresses and deformations are the biggest in these area. These support conditions imitate the conditions of the block as it was not cut on those sides.

On the three outer planes ( $x$ - $y$  located in the bottom,  $x$ - $z$  and  $y$ - $z$ ) of the soil structure the support conditions are placed all over the surface. They indicate that in reality the soil is much wider spread than it is shown in the model. In this way the program can take that fact into calculation. On each of those surfaces the support conditions allow the movement in both directions (2D problem), considering in which plane they are located.

The soil model has also two sides that appear to be “cut” in the same way as the concrete model for the same reason. Those are the planes in  $x$ - $z$  direction and  $y$ - $z$  direction and in both, only the movement along  $z$ -axis is allowed. Since those planes are actually the planes in the middle if the whole model is observed, and as the biggest settlements appears there, by allowing the movement in  $z$ -direction the actual state in reality in described.

The planes that have no support conditions are the top of the concrete structure in  $x$ - $y$  plane as well as outer  $x$ - $z$  and  $y$ - $z$  planes of the concrete structure. That is because they are external surfaces that are not bound by anything and are not affected by anything.

### *4.3.3 Loads*

The only load that will be considered is self-weight. For this massive block the self-weight is significant, and the idea of this master thesis was to see, if by taking it into consideration in different ways, the results of soil-structure interaction change and in what extend. More precisely, in the end the goal was to have better insight and to be able to reduce the risk of cracking.

In the model, by activating the self-weight in stages, as it happens in reality, the influence on stresses can be seen.

In first two models the self-weight is taken into account as in today's practice by saying the concrete is poured at once creating the block in one "phase".

In reality, concrete is poured layer-by-layer and for each layer in the model the two additional conditions were made. When pouring the concrete for each layer in the first moment the concrete has only a mass and no stiffness. Normally, after 28 days the concrete would have almost the full stiffness, but 28 days is too much time to wait during the construction and therefore the accelerators are used in order to speed up this process. Only when concrete in this layer achieves the sufficient stiffness the next layer of concrete can be poured and that was ensured by second condition.

This was done in program ASE by using two loops, were in first the concrete was given a mass but no stiffness and in second, next to the mass also the stiffness. This loop was done for all 16 layers that have been set at the beginning and conditions are controlled by command „group“.

#### 4.3.4 Numerical model

Using all given data about geometry, materials, mesh and loads three-dimensional (3D) mathematical model was created. Elements that were used to create both, concrete body and the soil, were BRIC (volume) elements. Those are solid six-sided elements with up to eight nodes.

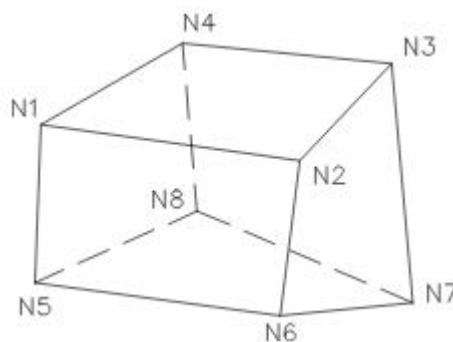

Figure 13: BRIC solid elements [10]

BRIC elements were defined in program sofimsha. In order to do that, first it was necessary to define that there are two different materials based on geometry. Three loops were defined in order to define three main directions and number of sections in each. After using the command “let” the boundary between the two bodies of the model is generated and depending on it the material is defined. In order to generate all BRIC elements all eight nodes for one element had to be defined and after, using generic transformations command, TRAN, the same principle was used for all elements in all three main directions as this command allow extrusion along direction or edge.

BRIC elements were used because the model represents big volumetric structures and therefore beam or plane elements can't be used. Volumetric elements provide more rigid nodes, compatibility in the overall model which results in a more realistic model.

After calculating the first model there were some inconsistencies with what was expected and what is known to happen in reality. Namely, the value of the stress in global x-direction at the top and at the bottom of the concrete block should be the same, only difference is in the type of strain. On the top there should be tension and at the bottom compression. These values were not even nearly the same.

The model was built of two materials with very different stiffness but because of the use of 3D, the connection between soil and concrete body is stiff. This resulted into giving the soil body the same stiffness in vertical and in horizontal direction when in reality the stiffness of the soil in horizontal direction is around 40% of stiffness in vertical direction. This assumption in some cases can be too optimistic and therefore, in the second model, as only difference regarding first, there is a small gap of 1 cm (in vertical direction) between concrete block and the soil. The gap was done by moving the concrete block up for 1 cm with command “TRAN”. With this gap in between, the two parts of the model are now acting independently one of the other. Since there has to be a connection between this two parts, in the next step they had to be connected but, in a way to free the horizontal movement to match the reality. To connect these two parts the couplings were used. Couplings are connecting the nodes that have same x and y coordinates. Nodes of the concrete block were known from before but since the whole block was moved up, the software had created the new nodes for soil body in places of connection between the two. To connect all the nodes of the concrete body with the nodes of the soil that are unknown, the loop that says to connect the known

nodes from the concrete body with the nodes with same x and y coordinates but with z-coordinate moved for 1 cm down was used. (Figure 14)

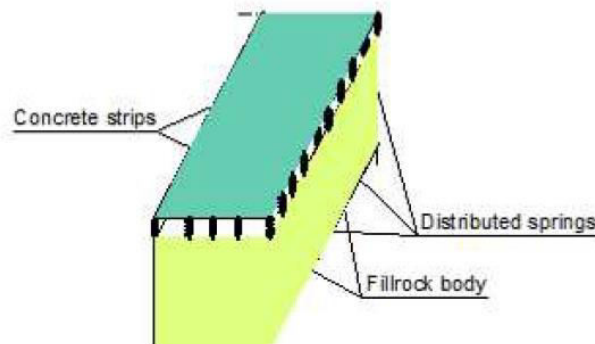

Figure 14: Couplings between concrete body and soil [7]

#### 4.4 Result analysis

All-in-once effect is represented in first two cases with small difference between them. Other models show what happens when construction process is considered. The casting consisted of 16 layers with 1 m height as well as with a delay of XX hours between each layer. In the following, different calculation approaches were tested. All the results will show 3D stresses in global x-direction on the front face of the concrete block.

##### 4.4.1 Model 1: “All-in-once” without horizontal interaction

The first case represents the simplest solution in which the self-weight of the whole block is switched on without any respect to construction process and stiffness evolution of the new concrete. Besides, the soil-structure interaction is limited to a vertical interaction with explicit exclusion of horizontal interaction. This was allowed by creating a gap of 1 cm between the soil and the block.

In order to understand better the stress results that will be shown later on for all the models, Figure 15 shows nodal displacement in global z-direction in bottom layer of the block in contact area with the soil. Nodal displacements are a repercussion of settlement which is caused by stresses.



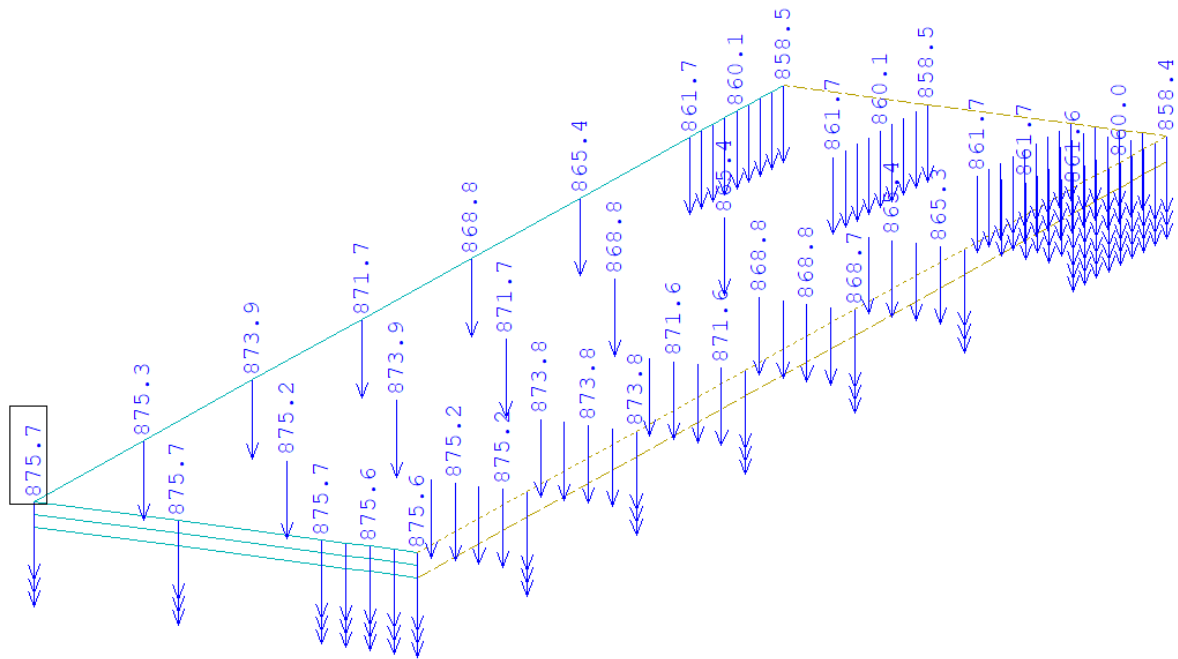
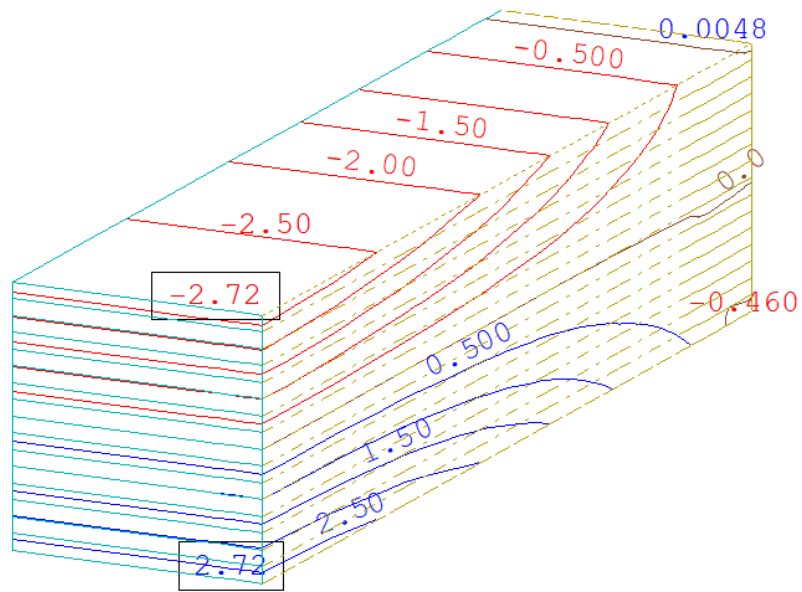

Figure 15: Nodal displacements in contact area in z-direction for model 1 in  
mm

The biggest nodal displacement happens in the left edge (on the figure), which is actually the middle of the whole concrete block. The load from upper layers is uniform which means that the internal forces are the biggest in the middle of the block. This is the reason why both, the stresses and the nodal displacement are the biggest right there. Going toward the end of the block the settlements are becoming smaller. This is especially seen in longitudinal direction as the distance is much bigger in this direction.

In order to understand better from where the stresses originate from, Figure 16 shows stress distribution in longitudinal direction through the block, looking from the symmetry face of the block towards the end of block the stresses decreases.



*Figure 16: Case 1 – Distribution of stresses in global x-direction*

With Figure 15 and Figure 16 the basic principle of nodal displacement and stress distribution through the block are presented and the same principle is applied for all 5 models. The difference is in the mode of distribution and the magnitude of the stresses that occur in the block for each model. To have a better picture of this differences, the 3D stresses are presented at the symmetry face of the block for each model.

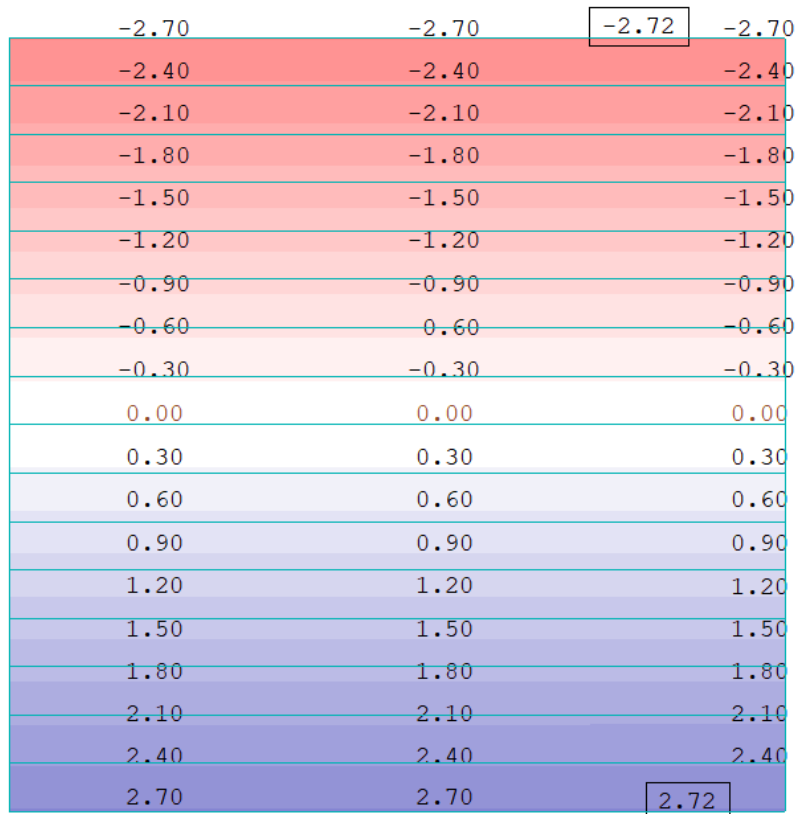

Figure 17: Model 1 – 3D stresses in global x-direction at the symmetry face of the block in MPa

Figure 17 shows the results of 3D stresses for model 1. As it can be seen, the values of stresses on the top and at the bottom of the concrete block are the same (2.72 MPa). Top of the block has compressive stress and on graph it is colored in red. As the value decreases the color becomes more and more pale. From around the middle of the block the compression stops, and the tension begins. Tensile stresses increase towards the bottom of the block and therefore the values are becoming bigger. In the figure, the tension is indicated with blue color. By coupling the concrete block and the soil the same value of stresses at the bottom and on the top of the concrete block was ensured as this is known to happen with existing structures.

Overall, this case shows how the self-weight is taken into calculation in most cases today and how it reflects the structure and the soil.

#### 4.4.2 Model 2: “All-in-one” with horizontal interaction

The second case is the same as the first with one exception, in this case the horizontal interaction wasn't excluded meaning the soil body has the same stiffness in both directions, vertical and horizontal which is not the case in reality. Based on researches, the horizontal stiffness of the soil is around 40% of the stiffness in vertical direction.

This stiff connection between concrete body and the soil would result in different values of stresses on the top and at the bottom of the concrete block as it is shown on Figure 18.

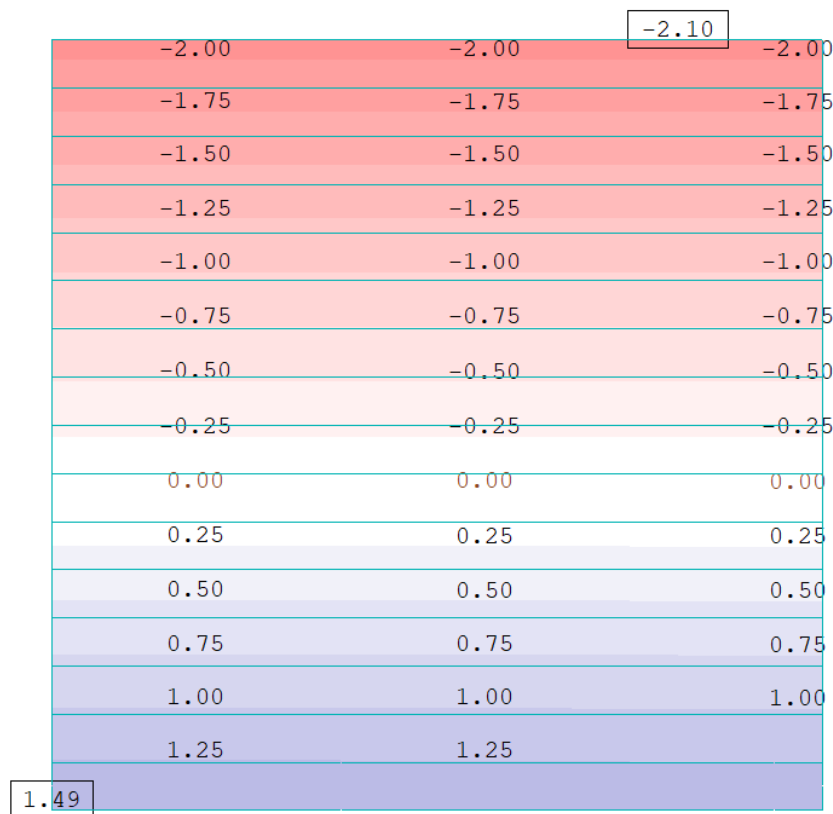

Figure 18: Model 2 – 3D stresses in global x-direction at the symmetry face of the block in MPa

Due to horizontal interaction between these two very different materials and their connection the concrete block is transferring additional stresses that result in different values on the top and at the bottom of the concrete block. Comparing the values on the top of the concrete block, compression in this case (-2.10 MPa) is smaller than when there is no horizontal interaction (-2.72 MPa). The area of tensile stresses in this case is smaller comparing to the

first as well as the value at the bottom, which means that the distribution is not symmetric as it was in the first case.

#### 4.4.3 Model 3: “Layer-by-layer” with immediate stiffness and without horizontal interaction

This case shows what happens with stress distribution if the layers of concrete block are turned one-by-one. Turning the layers one-by-one represents construction process. In this case at the same moment as the layers are turned on, they are given the mass and the stiffness while the inhomogeneous stiffness is taken into consideration.

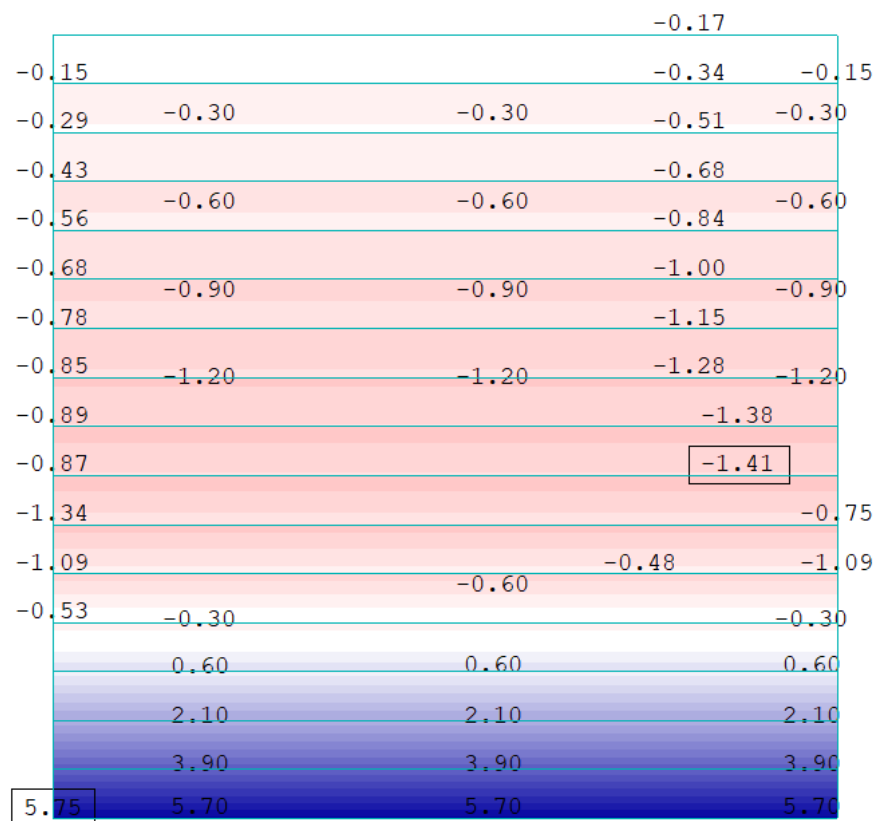
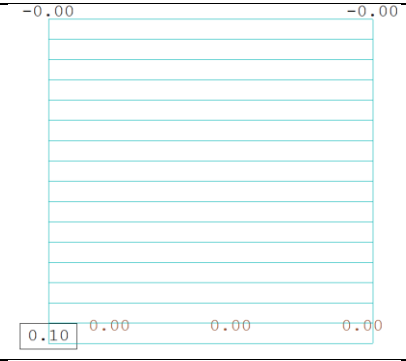
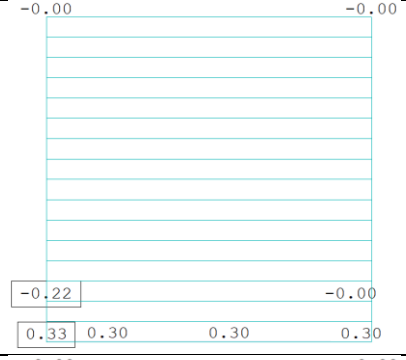
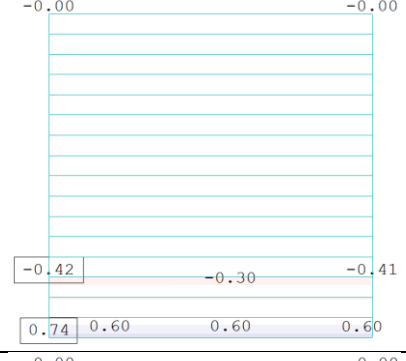



Figure 19: Model 3 – 3D stresses in global x-direction at the symmetry face of the block in MPa

To explain the difference the timely evolution is presented in Table 1Table 3.

Table 3: Model 3 – stress distribution layer-by-layer

Casting stage	Distribution of stresses in global x-direction	Explanation
1		<p><b>Time:</b> finishing of layer 1  <b>Stiffness:</b> layer 1 fully stiff  <b>Self-weight:</b> layer 1</p>
2		<p><b>Time:</b> finishing of layer 2  <b>Stiffness:</b> layer 1 to 2 fully stiff  <b>Self-weight:</b> layer 1 to 2</p>
3		<p><b>Time:</b> finishing of layer 3  <b>Stiffness:</b> layer 1 to 3 fully stiff  <b>Self-weight:</b> layer 1 to 3</p>
4		<p><b>Time:</b> finishing of layer 4  <b>Stiffness:</b> layer 1 to 4 fully stiff  <b>Self-weight:</b> layer 1 to 4</p>

5		<p><b>Time:</b> finishing of layer 5</p> <p><b>Stiffness:</b> layer 1 to 5 fully stiff</p> <p><b>Self-weight:</b> layer 1 to 5</p>
6		<p><b>Time:</b> finishing of layer 6</p> <p><b>Stiffness:</b> layer 1 to 6 fully stiff</p> <p><b>Self-weight:</b> layer 1 to 6</p>
7		<p><b>Time:</b> finishing of layer 7</p> <p><b>Stiffness:</b> layer 1 to 7 fully stiff</p> <p><b>Self-weight:</b> layer 1 to 7</p>
8		<p><b>Time:</b> finishing of layer 8</p> <p><b>Stiffness:</b> layer 1 to 8 fully stiff</p> <p><b>Self-weight:</b> layer 1 to 8</p>
9		<p><b>Time:</b> finishing of layer 9</p> <p><b>Stiffness:</b> layer 1 to 9 fully stiff</p> <p><b>Self-weight:</b> layer 1 to 9</p>

10	<p>Diagram showing bending moments (kNm) for layer 10. The diagram is divided into three sections of 1.33m each. The values are: -0.00, -0.00, -0.30, -0.72, -0.60, -1.30, -1.44, -1.20, -1.20, -1.40, -0.30, -0.30, 0.00, 1.80, 1.80, 1.80, 4.33, 4.20, 4.20, 4.20.</p>	<p><b>Time:</b> finishing of layer 10  <b>Stiffness:</b> layer 1 to 10 fully stiff  <b>Self-weight:</b> layer 1 to 10</p>
11	<p>Diagram showing bending moments (kNm) for layer 11. The diagram is divided into three sections of 1.33m each. The values are: -0.00, -0.00, -0.32, -0.60, -0.60, -0.93, -0.84, -1.38, -1.47, -1.20, -1.38, -1.38, -0.60, -0.30, -0.30, 1.80, 1.80, 1.80, 4.65, 4.50, 4.50, 4.50.</p>	<p><b>Time:</b> finishing of layer 11  <b>Stiffness:</b> layer 1 to 11 fully stiff  <b>Self-weight:</b> layer 1 to 11</p>
12	<p>Diagram showing bending moments (kNm) for layer 12. The diagram is divided into three sections of 1.33m each. The values are: -0.00, -0.00, -0.56, -0.23, -0.64, -1.07, -1.20, -1.43, -1.47, -1.20, -1.33, -1.33, -0.60, -0.60, 0.30, 2.10, 2.10, 2.10, 4.83, 4.80, 4.80, 4.80.</p>	<p><b>Time:</b> finishing of layer 12  <b>Stiffness:</b> layer 1 to 12 fully stiff  <b>Self-weight:</b> layer 1 to 12</p>
13	<p>Diagram showing bending moments (kNm) for layer 13. The diagram is divided into three sections of 1.33m each. The values are: -0.00, -0.00, -0.25, -0.40, -0.90, -0.72, -1.20, -1.16, -1.45, -1.20, -1.27, -1.27, -0.60, -0.60, 0.30, 2.40, 2.40, 2.40, 5.17, 5.10, 5.10, 5.10.</p>	<p><b>Time:</b> finishing of layer 13  <b>Stiffness:</b> layer 1 to 13 fully stiff  <b>Self-weight:</b> layer 1 to 13</p>
14	<p>Diagram showing bending moments (kNm) for layer 14. The diagram is divided into three sections of 1.33m each. The values are: -0.00, -0.00, -0.43, -0.18, -0.60, -0.60, -0.85, -0.67, -1.20, -1.20, -1.22, -0.90, -1.45, -1.42, -1.21, -0.60, -0.60, 0.30, 2.40, 2.40, 2.40, 5.89, 5.10, 5.10, 5.10.</p>	<p><b>Time:</b> finishing of layer 14  <b>Stiffness:</b> layer 1 to 14 fully stiff  <b>Self-weight:</b> layer 1 to 14</p>



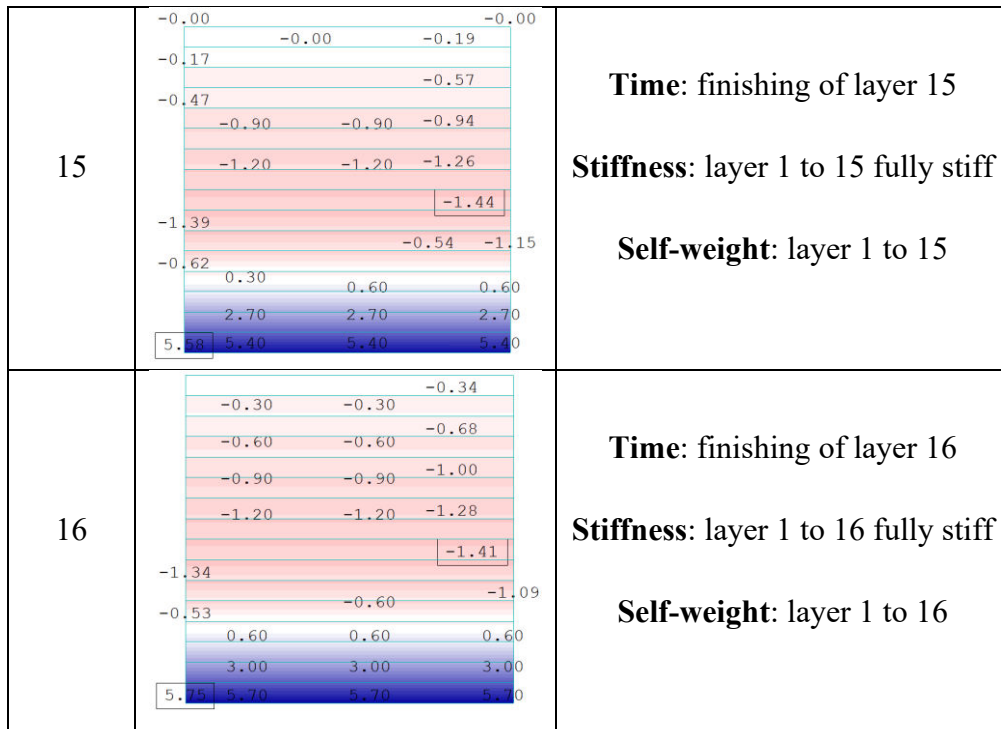

Turning the layers on, the tensile stress at the bottom increases until the value of 5.75 MPa. Already here the influence of phased construction can be seen since the value of the stresses at the bottom are more than doubled compared to model 1 where the influence of phase construction wasn't taken into account.

#### 4.4.4 Model 4: "Layer-by-layer" with delayed stiffness and with horizontal interaction

As in the previous case the load is applied in layers, but the time needed for each layer to create its stiffness is taken into consideration. The gap between concrete body and the soil here wasn't modeled which means that the horizontal interaction exists which doesn't really correspond the reality. Figure 20 shows stress results when all 16 layers are on.

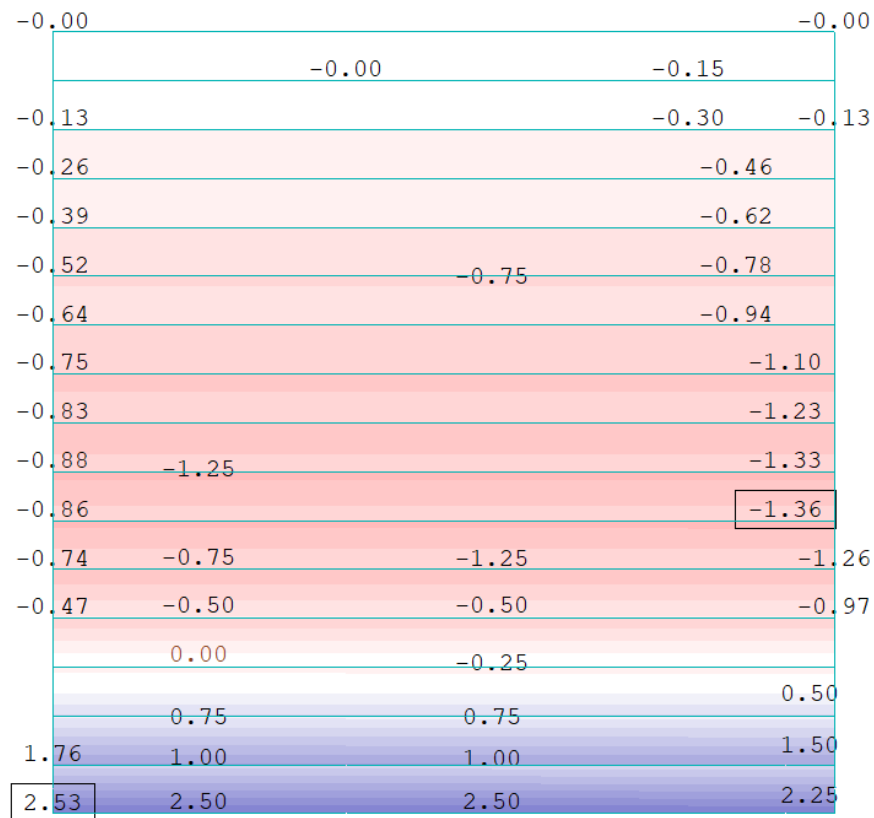

Figure 20: Model 4 – 3D stresses in global x-direction at the symmetry face of the block in MPa

With value of 2.53 MPa the biggest tension is at the left edge in the bottom of the model as in the previous cases. Going toward the middle (by height) the pressure increases but slightly. The strongest compression of -1.36 MPa is in the middle of the right edge and from there going toward the top it decreases and at the top it reaches 0.0 MPa.

#### 4.4.5 Model 5: “Layer-by-layer” with delayed stiffness and without horizontal interaction

In this case all the factors of construction process have been taken into account so that it matches the reality fully. That, in theory, makes this case the most representative of all.

Same as the structures that are being built, the model was also build layer-by-layer. Time needed for the first layer to develop its stiffness was considered as well as the difference in stiffness of soil in the horizontal and vertical direction. The results how it influences the

stresses by layers is shown in Table 4 while for better comparison to previous models the final result is shown in Figure 21.

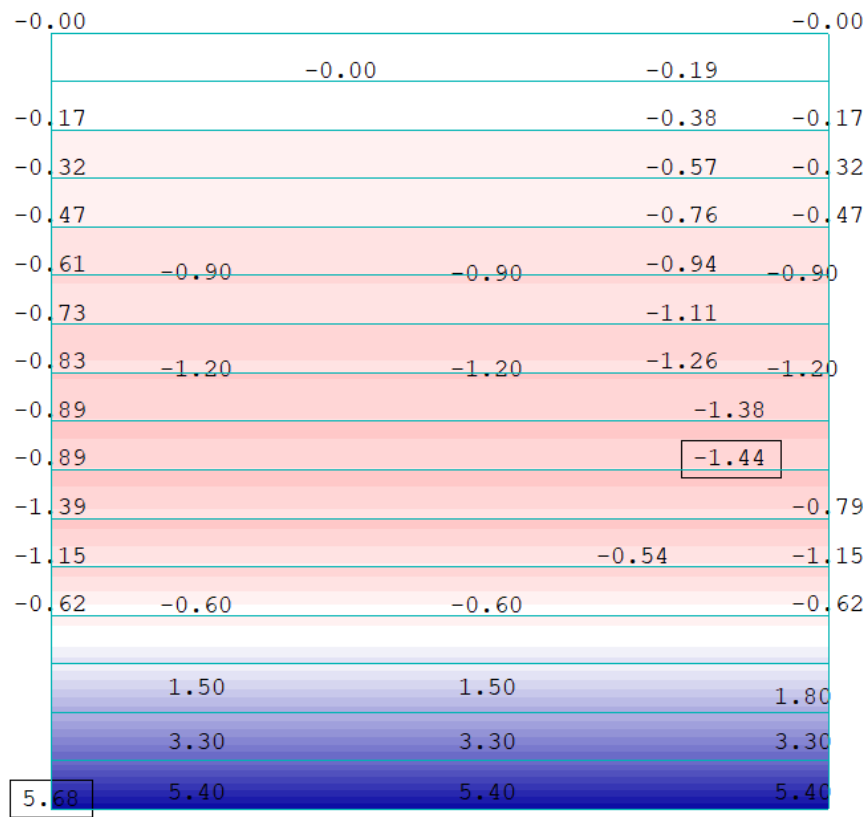

Figure 21: Model 5 – 3D stresses in global x-direction at the symmetry face of the block in MPa

Table 4: Model 5 – stress distribution "layer-by-layer" with delayed stiffness and without horizontal interaction

Casting stage	Distribution of stresses in global x-direction	Explanation
1		<p><b>Time:</b> finishing of layer 1  <b>Stiffness:</b> no stiffness  <b>Self-weight:</b> layer 1</p>
2		<p><b>Time:</b> finishing of layer 2  <b>Stiffness:</b> layer 1 fully stiff  <b>Self-weight:</b> layer 1 to 2</p>
3		<p><b>Time:</b> finishing of layer 3  <b>Stiffness:</b> layer 1 to 2 fully stiff  <b>Self-weight:</b> layer 1 to 3</p>
4		<p><b>Time:</b> finishing of layer 4  <b>Stiffness:</b> layer 1 to 3 fully stiff  <b>Self-weight:</b> layer 1 to 4</p>

5		<p><b>Time:</b> finishing of layer 5</p> <p><b>Stiffness:</b> layer 1 to 4 fully stiff</p> <p><b>Self-weight:</b> layer 1 to 5</p>
6		<p><b>Time:</b> finishing of layer 6</p> <p><b>Stiffness:</b> layer 1 to 5 fully stiff</p> <p><b>Self-weight:</b> layer 1 to 6</p>
7		<p><b>Time:</b> finishing of layer 7</p> <p><b>Stiffness:</b> layer 1 to 6 fully stiff</p> <p><b>Self-weight:</b> layer 1 to 7</p>
8		<p><b>Time:</b> finishing of layer 8</p> <p><b>Stiffness:</b> layer 1 to 7 fully stiff</p> <p><b>Self-weight:</b> layer 1 to 8</p>
9		<p><b>Time:</b> finishing of layer 9</p> <p><b>Stiffness:</b> layer 1 to 8 fully stiff</p> <p><b>Self-weight:</b> layer 1 to 9</p>

10	<p>Diagram showing bending moments for layer 10. Values range from -1.44 to 4.43.</p>	<p><b>Time:</b> finishing of layer 10  <b>Stiffness:</b> layer 1 to 9 fully stiff  <b>Self-weight:</b> layer 1 to 10</p>
11	<p>Diagram showing bending moments for layer 11. Values range from -1.47 to 4.75.</p>	<p><b>Time:</b> finishing of layer 11  <b>Stiffness:</b> layer 1 to 10 fully stiff  <b>Self-weight:</b> layer 1 to 11</p>
12	<p>Diagram showing bending moments for layer 12. Values range from -1.47 to 5.03.</p>	<p><b>Time:</b> finishing of layer 12  <b>Stiffness:</b> layer 1 to 11 fully stiff  <b>Self-weight:</b> layer 1 to 12</p>
13	<p>Diagram showing bending moments for layer 13. Values range from -1.45 to 5.28.</p>	<p><b>Time:</b> finishing of layer 13  <b>Stiffness:</b> layer 1 to 12 fully stiff  <b>Self-weight:</b> layer 1 to 13</p>
14	<p>Diagram showing bending moments for layer 14. Values range from -1.45 to 5.49.</p>	<p><b>Time:</b> finishing of layer 14  <b>Stiffness:</b> layer 1 to 13 fully stiff  <b>Self-weight:</b> layer 1 to 14</p>

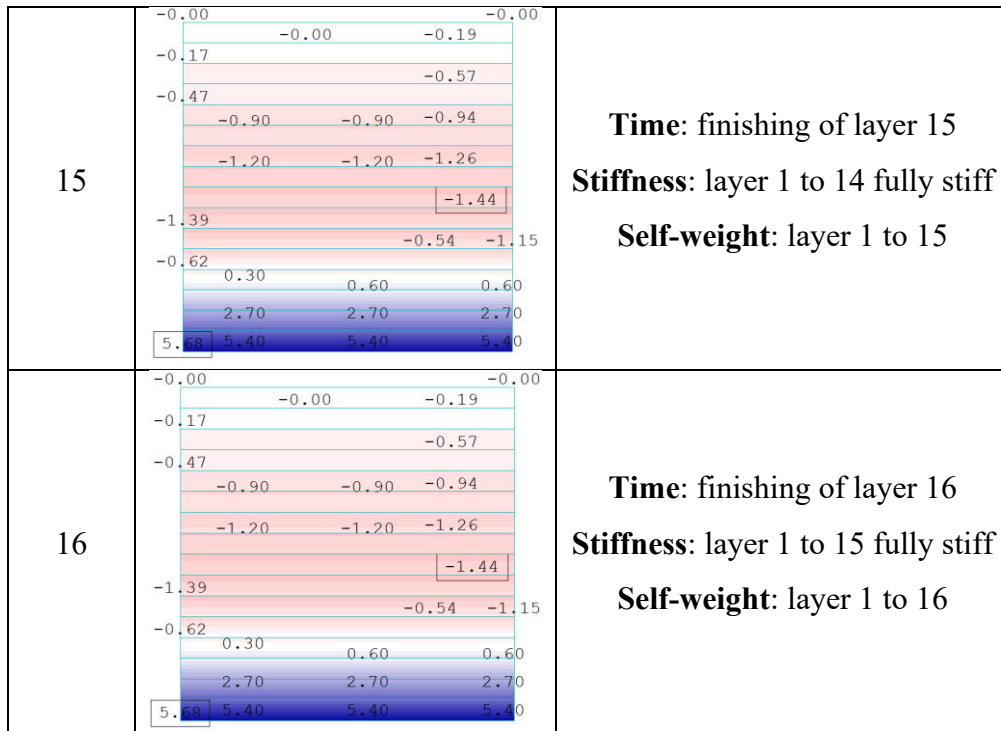

At the bottom of the model tensile stresses occur and the value increases as adding the layers. The area of tensile stresses is smaller than area of compression stresses, but the value of tensile stresses is much larger.

## 4.5 Discussion on Case 1

Table 5: Overall of all five cases

	Model 1: “All-in-one” without horizontal interaction	Model 2: “All-in-one” with horizontal interaction	Model 3: “Layer-by- layer” with immediate stiffness and without horizontal interaction	Model 4: “Layer-by-layer” with delayed stiffness and with horizontal interaction	Model 5: “Layer-by- layer” with delayed stiffness and without horizontal interaction
$\sigma_x$					

Table 5 shows stress diagrams of all five models when all 16 layers are on. The big difference in results can be seen between model 1 and model 3/model 5.

In the first model the distribution is symmetric, linear, with compression and tension values (+/-) 2,72 MPa. In model 3 and 5 the distribution isn't linear, moreover the stress value at the top is almost zero. In today's engineer practice the self-weight is taken into account as in model 1 while the real influence of self-weight is shown in model 5. Those two cases are very different, both with values and with the stress distribution. Based on this, the conclusion is that in such large structures the way of taking the self-weight into account plays a big role.

Looking the results from model 3 and model 5 the values aren't that different. In model 5 the delay in stiffness was taken into the account which corresponds situation in reality. Tension, with value of 5,75 MPa is slightly bigger in model 3 while the biggest compression (-1,44 MPa) and the compression at the top of the block (-0,19 MPa) is slightly bigger in model 5. With these small differences in values it is correct enough not to take the delayed

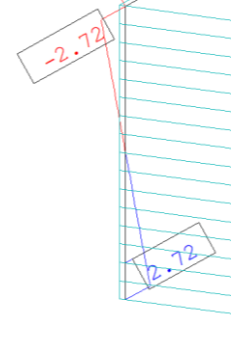
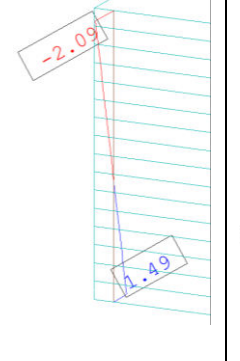
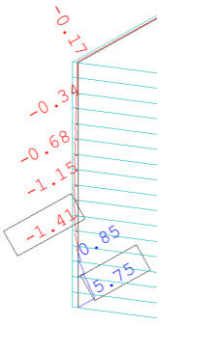
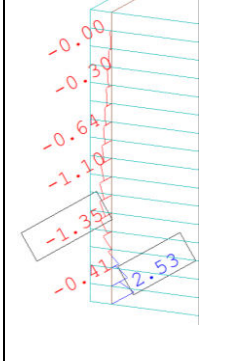
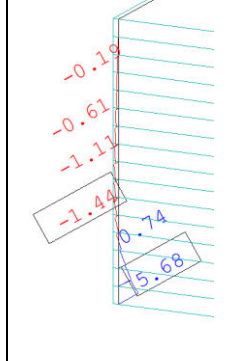

stiffness into account. This simplifies and speeds up the calculation even more for structures with more complex geometry.

One of the particularities of the soil is its anisotropic behavior. This is due to the fact that the soil has different stiffness in horizontal and vertical direction. In models 2 and 4 this fact is neglected, and the soil is modeled as equally rigid in all directions. By comparing the stress results of models when the construction process is taken into account, the differences in values are significant. In model 4 the soil was modeled as stiff, while in the models 3 and 5 there is a gap in the models between soil and structure ensuring no horizontal interaction meaning the soil is stiff in vertical but not in horizontal direction. For this structure the tension value in model 4 is halved comparing to models 3 and 5. This leads to a conclusion that this is a big fact in analyzing and calculating such structures which means if it is not taken into account the results of analysis will show smaller bending moments leading to wrong calculation of required reinforcement. The wrong amount of reinforcement means that the risk of cracking is bigger because the installed reinforcement may not be sufficient to take on all the loads and their effects that may have been foreseen, but due to a mistake in the interpretation of the soil the results gave wrong values.

## 5. CASE 2: 7-FLOOR BUILDING

### 5.1 Case description

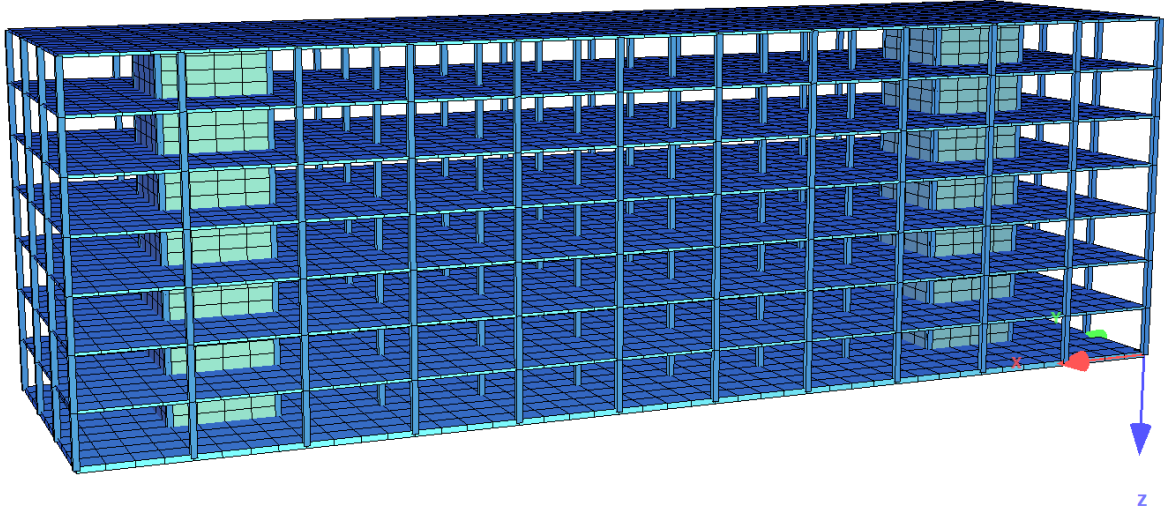

Figure 22: Illustration of case 2

Figure 22 shows a representation of a phased constructed building that consists of slabs, columns and cores. This 7-floor building has 8 slabs in total, where the ground slab has thickness  $t_{\text{base}} = 0,4$  m while all other slabs have a thickness of  $t_{\text{slab}} = 0,2$  m. The dimensions of slabs,  $B \times L = 21 \times 77$  m, are also the dimensions of the building itself. Columns have square cross-section,  $b_{\text{col}} \times b_{\text{col}} = 0,4 \times 0,4$  m, and they extend on all 7 floors. The distance between columns in plane x-y is 7 meters in both directions which makes 48 columns per floor. The height of each column is 3,5 meters which corresponds to height of each floor. The last structural element of the building are two cores, both with dimensions  $5 \times 5$  meters and a wall thickness of  $t_{\text{core}} = 0,3$  m. They are extending through the whole building and they are located along x-axis where each is 7 meters away from the outside edge of the building.

A concrete with strength class of C 30/37 and secant modulus of elasticity of 32 000 MPa was used with and all its technical properties according EN 1992-1-1. For reinforcement, steel B 500 B was used also according to the same code.

Unlike in the first case, the ground on which the structure is located is not modeled as a 3D soil body, but it is simplified by assuming a linear-elastic half space. The elastic half space is the volume in which the particle of soil will deform when loaded. It is one of many possible models to be used to describe what happens in the soil after applying the loads on it. In order to analyze the half space and the settlements the command BORE was used to describe the soil characteristics. In this case for simplification only one soil profile was used with its stiffness of 5 000 kN/m<sup>2</sup>.

## 5.2 Motivation for behind case 2 and its model's

At this type of structures, the ground slab is the only one in a direct contact with the soil and therefore it is important to analyze all effects on it. One of those effects is precisely due to soil-structure interaction and it manifests in horizontal stresses. The effect of a vertical load transfer is not regarded in this work. The result of the analysis is a reinforcement design for crack control which is of very high importance especially for ground slab since this slab is in contact with other material and transfers all the load from the building into the soil.

Total stresses in a ground slab are the result of stresses from a horizontal interaction,  $\sigma_N$  and bending of a slab,  $\sigma_M$ . Further explanation will be given in chapter 5.4.4.

The general assumption in this case is that SSI in some percentage of buildings has a meaningful significance. The assumption is that the bending moment in the slabs will get bigger with higher floors which will result in high tensile forces in the ground slab. This leads to different reinforcement designs in order to assure the slab against cracks. To this end, a parametric study has also been performed to determine the general type of the structures in which this assumption is affected.

## 5.3 Modeling

### 5.3.1 Mesh generation

The mesh of the structure is pretty simple. Each element has its own division. Slabs have the same number of partitions between columns in both, x- and y-direction. Mesh fineness for slabs is 1,75 m which means that from column to column there are 4 partitions. The same

number of partitions as slabs have both cores, but even though the number of partitions is the same, the mesh fineness in z-direction is different while in x- and y-direction is the same. In z-direction the size of a partitions is 0,875 m which results out of the geometry because the height of the core per floor is 3,5 m. Each column is a separate element on each floor so it makes a separate partition. Even though the problem is 3D, all elements used to describe it are 2D so the finite elements are also 2D.

### *5.3.2 Loads*

In this case there are two different load simulations. One is done by program ASE in which the phased construction process is described while the second one is done by program SOFILOAD and it represents the current state of taking the self-weight into account without regards to construction process.

In general, the construction phases are formed depending on the type of the structure, its layout, construction site organization and mechanization. The structure is divided in phases and each phase activates separately with the condition that the next phase can be activated only when the previous phase had reached sufficient stiffness.

For this case, 7 phases were formed where the first phase includes ground slab with its full stiffness and self-weight, all the vertical elements with their stiffnesses and self-weights and the slab from the first floor that has self-weight and a bending stiffness but no axial stiffness. In second phase the slab of the first floor develops axial stiffness. This phase also includes all the vertical elements with full self-weights and stiffness as well as the slab of the second floor that has a self-weight and a bending but no axial stiffness. Repeating this principle until the top all the phases were modeled.

### *5.3.3 Numerical model*

The model is formed in program Sofimsha. Nodes had to be defined first in order to define slabs, columns and cores. To each type of element a group number is assigned and each element of that group on the same floor is numbered the same so that elements can be more easily controlled. The reason for this is phased construction. In phased construction different

elements are being casted at the same time and in this way the structure is moving up. Between each phase there is a pause in order for concrete to harden so that the elements from the next phase can be casted.

Using QUAD elements and giving them a group number 100 the slabs were modeled. With group control command, GRP, each slab has starting group number 100 plus the unit number of floor on which it is located. For example, the ground floor slab has a group number 100 while the top slab has group number 107. Group number 200 is associated with columns that were modeled using BEAM elements. All the columns on the same slab have the same group number and the principle is the same as for the slabs. The last are two cores. They were modeled using QUAD elements for all four sides. The number of their group is 300 while the first QUAD elements of both cores on the ground floor have group number 301 and the principle for each floor is  $300 + \#i + 1$  where “i” is floor index.

Figure 23 shows the list of all groups describing the building with its element type.

Groups		
Grp	number	Type
100	528	QUAD
101	528	QUAD
102	528	QUAD
103	528	QUAD
104	528	QUAD
105	528	QUAD
106	528	QUAD
107	528	QUAD
201	48	BEAM
202	48	BEAM
203	48	BEAM
204	48	BEAM
205	48	BEAM
206	48	BEAM
207	48	BEAM
301	128	QUAD
302	128	QUAD
303	128	QUAD
304	128	QUAD
305	128	QUAD
306	128	QUAD
307	128	QUAD

Figure 23: List of groups [11]

## 5.4 Result analysis

For better comparison, four different models were created and analyzed. For these reason in two models the self-weight is activated all-in-once as it is todays practice in calculation of all building types. Other two models where created in accordance to phased construction process, where the self-weight of a particular phase is activated only when the individual phase is being “build” and not before. The second variable considered is horizontal stiffness. In two models the horizontal stiffness is defined with 40% in x- and y-direction and in the next two models it is assumed that the horizontal stiffness does not exist and it is defined as zero in x- and y-direction. In all four models the stiffness in z-direction is 100%. The stiffness is controlled in program called HASE which is a program to define halfspace.

For all four models the results of horizontal stresses in the ground slab will be presented and discussed. The last model is representative so additional results are provided.

### 5.4.1 *Model 1: “All-in-once without horizontal interaction”*

In this model the self-weight of the whole building is activated at the same time. Between the soil and ground slab there is no horizontal interaction which is achieved by deactivating the horizontal stiffness. Horizontal stresses that occur in ground slab as a repercussion are showed in Figure 24.

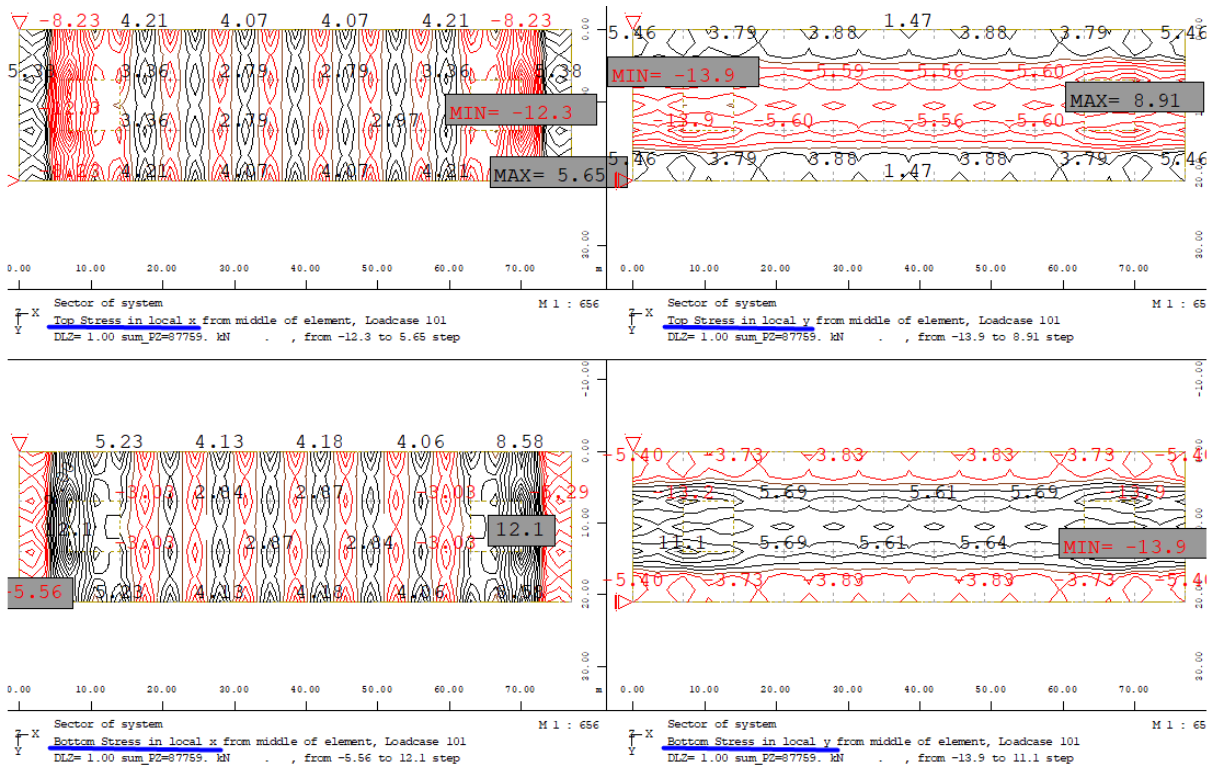

Figure 24: Model 1 - Horizontal stresses in MPa

Two upper pictures show top stresses in x- and y-direction while bottom pictures show bottom stresses.

#### 5.4.2 Model 2: “All-in-once with horizontal interaction”

In this model as only difference to the first model, the horizontal stiffness of 40% is assumed.

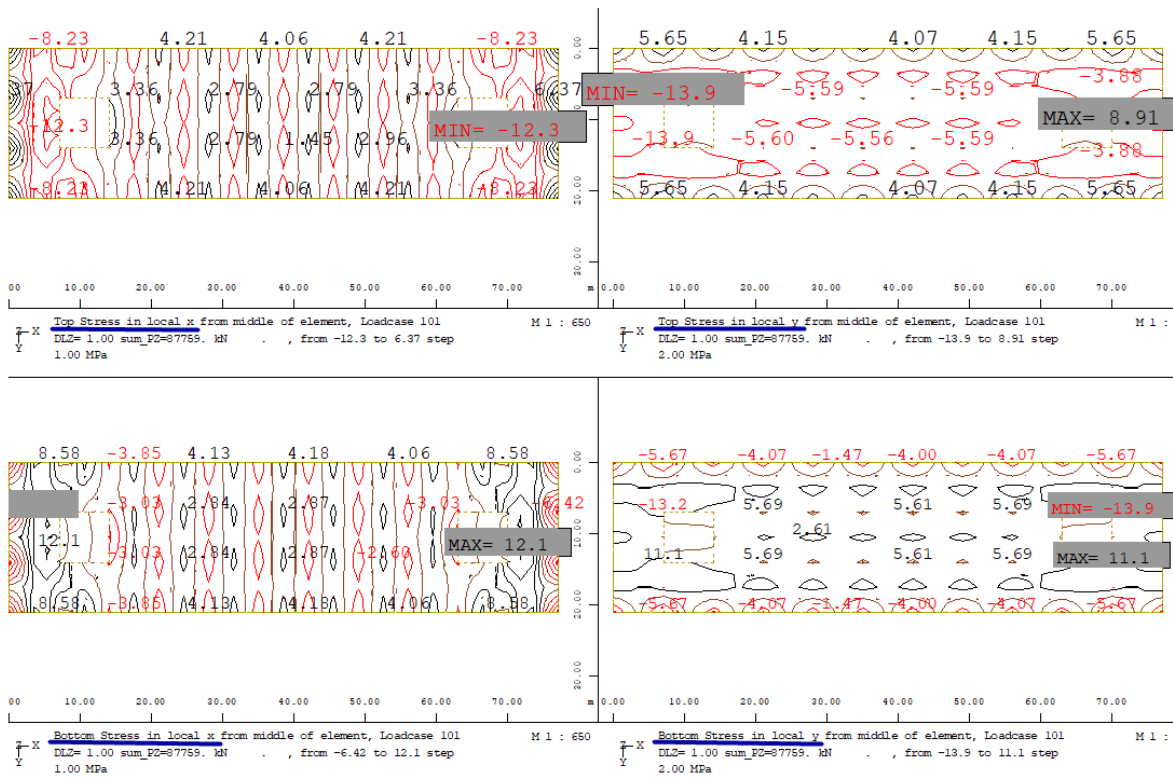

Figure 25: Model 2 - Horizontal stresses in MPa

### 5.4.3 Model 3: "Phased construction with horizontal interaction"

In this case the phased construction process was considered with interaction between the building and the soil in horizontal direction. Horizontal stress results are showed in Figure 26.



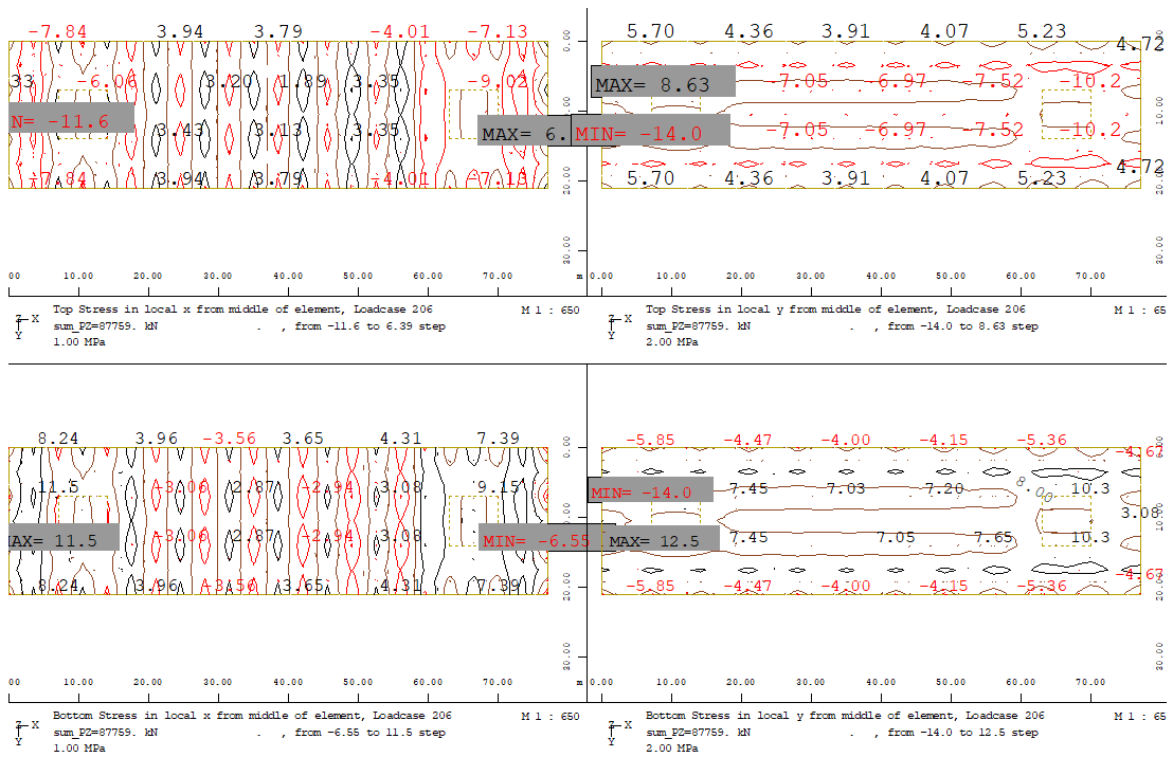

Figure 26: Horizontal stresses in MPa

#### 5.4.4 Model 4: “Phased construction without horizontal interaction”

This is the most representative model for purpose of this investigation because it considers the actual way of construction. Another aspect included in this model is that there is no horizontal interaction between the building and subsoil.

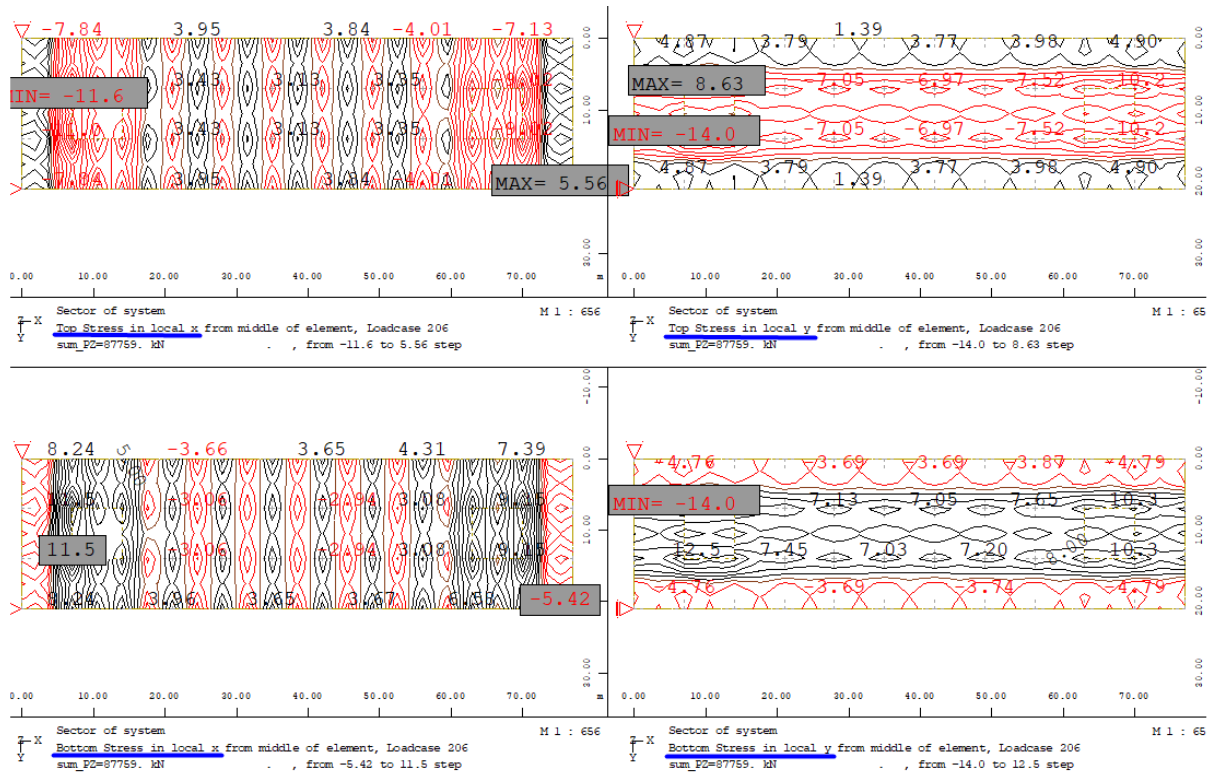

Figure 27: Model 4 - Horizontal stresses in MPa

Like in previous models, Figure 27 shows top and bottom horizontal stresses for this model.

Looking at the values and comparing them to the first model it can be seen that they almost don't differentiate which takes us to the conclusion that for this type of geometry it is not needed to make more detailed SSI investigation.

Total stresses shown in Figure 27, in FE model they are the sum of stresses from horizontal interaction and the stresses that come from bending of slabs. The stresses that are the result of horizontal interaction can not be seen directly but they can be determined by membrane force divided by cross-section area of the slab. Figure 28 shows membrane force in local x-direction in ground slab when all the phases are done.

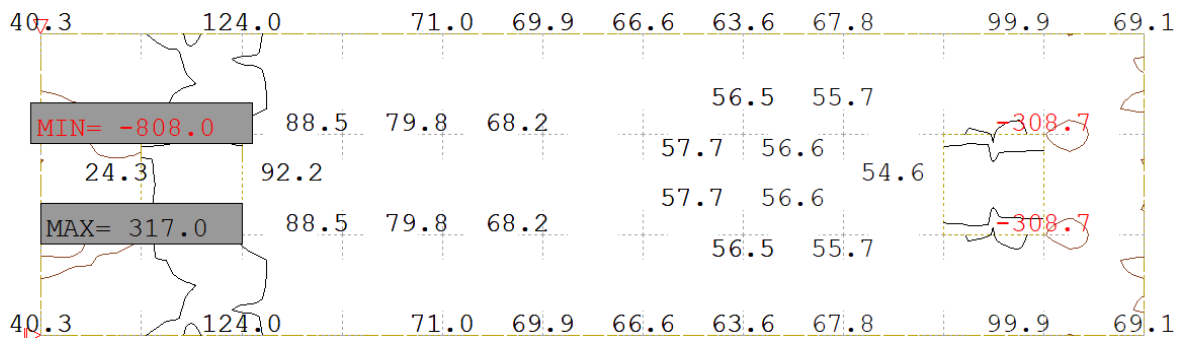

Figure 28: Membrane force in ground slab in local x-direction in kN/m

The maximal membrane force in slab is 317,0 kN/m and the area of slab is 0,4 m x 1,0 m where 0,4 m is the thickness of a slab and 1,0 m is a running meter for which the stress is calculated:

$$\sigma_N = \frac{F}{A} = \frac{317,0}{0,4 \times 1,0} = 792,5 \frac{kN}{m^2} = 0,79 MPa \quad (10)$$

This result is very small which is another indication that for this geometry the SSI doesn't play a big role in forming the total response of the building.

According to EUROCOD for SLS all deformations of a slab have to be below the limit which in this case is:

$$\delta < \frac{L}{500} = \frac{55000}{500} = 110 mm \quad (11)$$

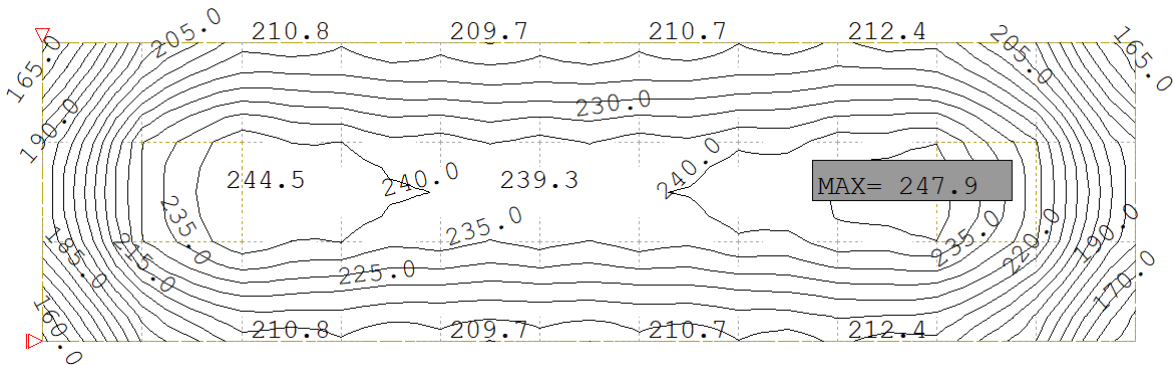

Figure 29: Nodal displacement in ground slab in global z-direction in mm

Figure 29 shows that the maximum displacement is twice the permissible limit. This can also be a repercussion of a weak soil, so one possible solution is to increase the slab thickness, or in this case even the soil strength.

The biggest displacements are below the cores which is to be expected but looking at iso lines and comparing the values of displacement around the cores and taking into account the distance between one possible problem raises. Namely, the displacement of upper left corner (looking at the picture) is 165,0 mm which sets the difference of 82,9 mm at a distance of ca. 14 m from the maximum settlement of 247,9 mm which is not negligible. This could be reduced if there would be a better load transfer from around the cores to the rest of the slab area.

All of this is important for reinforcement design for crack control. In the case of buildings, the effects of all acting loads on the building need to be well analyzed to ensure that the

reinforcement plan is as accurate as possible in order to prevent significant cracks that may lead to major problems in the function of the building as a structure. Table 6 shows design plan of upper and lower reinforcement for 1<sup>st</sup> and 2<sup>nd</sup> layer (principal and cross reinforcement).

Table 6: Reinforcement design for ground slab in cm<sup>2</sup>/m

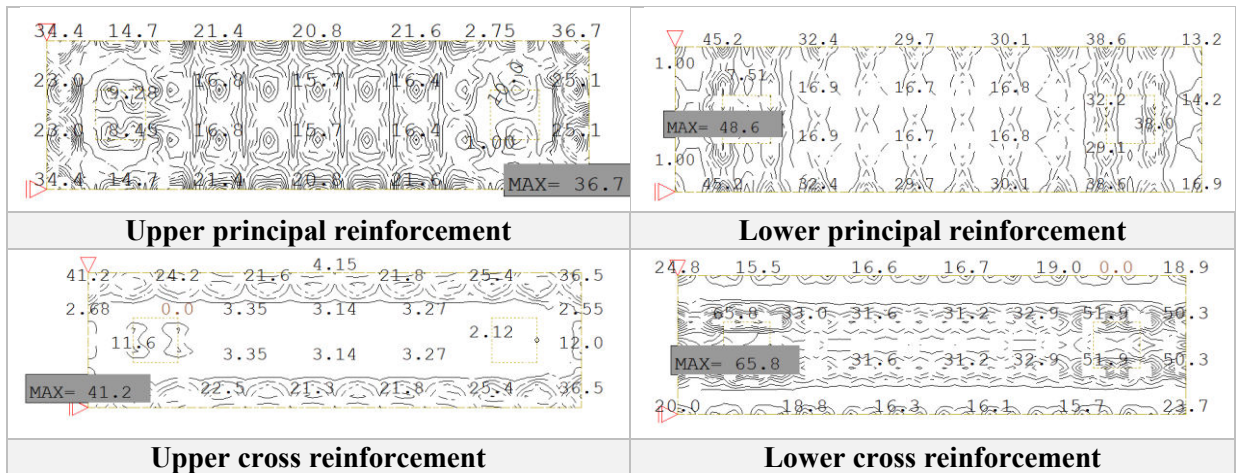

Reinforcement is shown with iso lines for better illustration of how much reinforcement is needed in which area. Grater amount of principal reinforcement at the bottom of the slab is needed below the cores where maximum value of 48,6 cm<sup>2</sup>/m which corresponds to 26Φ16 (52,28 cm<sup>2</sup>/m). A large amount of cross reinforcement in this case is also required along longitudinal direction at the middle of y-direction. Here, below the cores the reinforcement of 65,8 cm<sup>2</sup>/m needs to be provided while between the cores twice less.

The results of the required reinforcement are quite high as a result of large deformations and not financially profitable. This suggest the need of better model optimization in static terms.

## 5.5 Discussion on Case 2

Viewing the stress results of all four models it can be seen that there is no significant difference. For better illustration in Table 7 is the comparison of top stress results in x-direction.

Table 7: Top stresses in x-direction in MPa

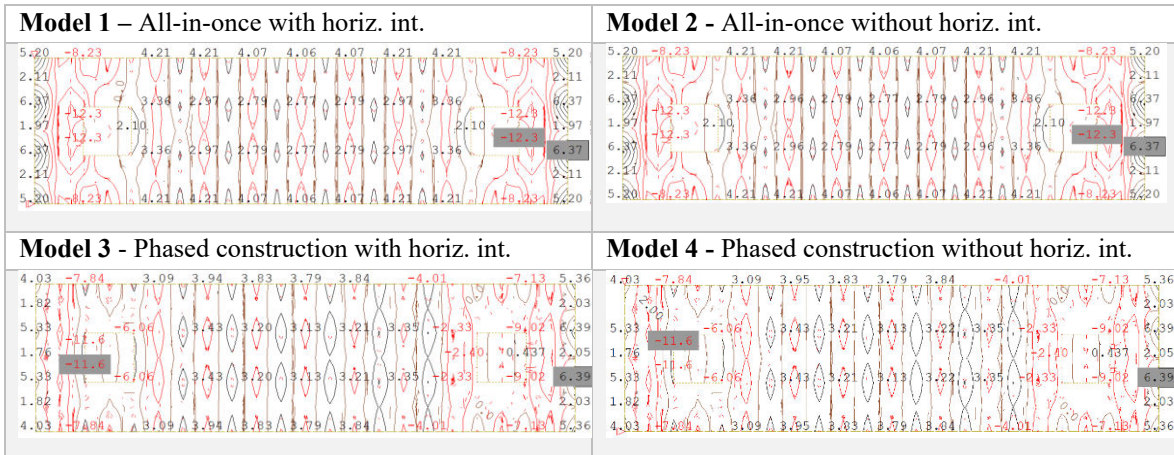

On the basis of these results, it has already been concluded that this type of building geometry is not representative, that is, the interaction of soil and structure makes similar results in both cases, when the construction phases are taken into account and when they are disregarded. Therefore, the initial hypothesis was not confirmed.

In order to find a geometry where this might make a more significant difference a parametric study was performed. As far as geometry is concerned, the current geometry was a starting point and parameters subject to change are the thickness of the ground slab, the spacing between the columns and the number of partitions that result in change of total length of the building. In addition to these variables, soil stiffness makes the last parameter. Settings for model 1 and model 4 are representative for new models where above-mentioned parameters were changed. The ratios between needed principle reinforcement in the ground slab are comparison parameter. Parametric study is presented in Table 1 Table 8.

Table 8: Parametric study

Parametric study							
Case	Ground slab thickness [m]	Distance between columns [m]	Number of partitions	Building length	Soil stiffness [kN/m <sup>2</sup> ]	Asl,aio/Asl,pc [-]	Asu,aio/Asu,pc [-]
1	0,40	7	11	77	5000	1,07	1,08
2	0,55	7	11	77	5000	1,24	1,08
3	0,55	7	11	77	15000	1,21	1,09
4	0,55	5	11	55	5000	1,01	0,84
5	0,55	5	11	55	15000	1,16	1,05
6	0,55	5	6	30	5000	0,98	0,77
7	0,55	5	6	30	15000	1,12	1,00
8	0,55	7	6	42	5000	1,20	0,96
9	0,55	7	6	42	15000	1,20	1,05
10	0,55	5	16	80	5000	1,02	0,87
11	0,55	5	16	80	15000	1,15	1,07
12	0,55	7	16	112	5000	1,22	1,12
13	0,55	7	16	112	15000	1,19	1,10
14*	0,55	7	16	112	10000	1,20	1,10
15*	0,55	7	20	140	10000	1,18	1,11
16*	0,55	5	20	100	10000	1,07	1,06
17	0,65	7	11	77	5000	1,33	1,05
18	0,65	7	11	77	15000	1,34	1,09
23	0,65	5	11	55	5000	1,04	0,70
22	0,65	5	11	55	15000	1,23	1,02
23	0,65	5	6	30	5000	0,96	0,63
24	0,65	5	6	30	15000	1,17	0,93
25	0,65	7	6	42	5000	1,25	0,93
26	0,65	7	6	42	15000	1,31	1,06
27	0,65	5	16	80	5000	1,03	0,79
28	0,65	5	16	80	15000	1,21	1,05
29	0,65	7	16	112	5000	1,30	1,09
30	0,65	7	16	112	15000	1,32	1,11
31*	0,65	7	16	112	10000	1,31	1,10
32*	0,65	7	20	140	10000	1,29	1,09
33*	0,65	5	20	100	10000	1,07	0,96

The red text indicates results related to the first and third remark, while green text indicates results relevant to the second remark.

#### REMARK 1:

In results with slab thickness of 0,55 meters it can be seen that independently on length of a building (30 m, 55 m, 80 m), if the spacing between the columns is smaller (5 m) as well as if the soil is weaker (5 MP), than the ratio of lower reinforcement is pretty low ca. 2% which means that approximately the same amount of lower reinforcement is needed. This is not the case with upper reinforcement where the ratios between model all-in-once and model of phased construction are higher than 10%, more accurate 23% for building length of 30 m, 16% for building length of 55 m and 13% for building length of 80 m. This ratio decreases with building length. Significant is that for all three building lengths for case of upper reinforcement the model of phased construction needs more reinforcement than model all-in-once.

This is also valid when the ground slab thickness is 0,65 m the only difference is that in case of upper reinforcement the ratios are even bigger, 37% for building length of 30 m, 30% for building length of 55 m and 21% for building length of 80 m.

This means that the thicker the ground slab is the ratio for upper reinforcement gets bigger.

Even though the ratios for lower reinforcement are small, the parametric study shows us that for small building lengths (in this case 30 m) more reinforcement needs to be put in model where the phased construction is considered.

#### REMARK 2:

In models where the spacing between columns is bigger (7 m) it can be noticed that when the length of buildings is bigger (77 m and 112 m) the results for both, upper and lower reinforcement differ only up to 3% if the results of weak soil (5 MPa) and stiffer soil (15 MPa) are mutually compared.

In models where the total length of the building is small (42 m) the results differ in case when the thickness of ground slab is 0,55 m and when it is 0,65 m. When the thickness of ground slab is 0,55 m the ratio for lower reinforcement in cases of weak and stiff soil is the same and it is 20% while in case of thicker slab the ratio of 31% is bigger in model with stiffer soil (whereby in weaker soil is 25%). Here also in models with weaker soil and phased construction taken into account, more upper reinforcement needs to be put in ground slab.

REMARK 3:

Only time when difference between all-in-once and phased construction is more significant (more than 20% → in case of ground slab thickness of 0,65 m) for upper reinforcement its when soil is when soil is weaker (5 MPa) and spacing between columns is smaller (5 m) - (same conditions as in remark 1).

In models when the ground slab is 0,55 m thick the ratios are >10%. This means that is grows as the ground slab is thicker.

In all other combinations of parameters this ratio for upper reinforcement is less then 10%.

Graphical representation of parametric study results is given on Figure 30.

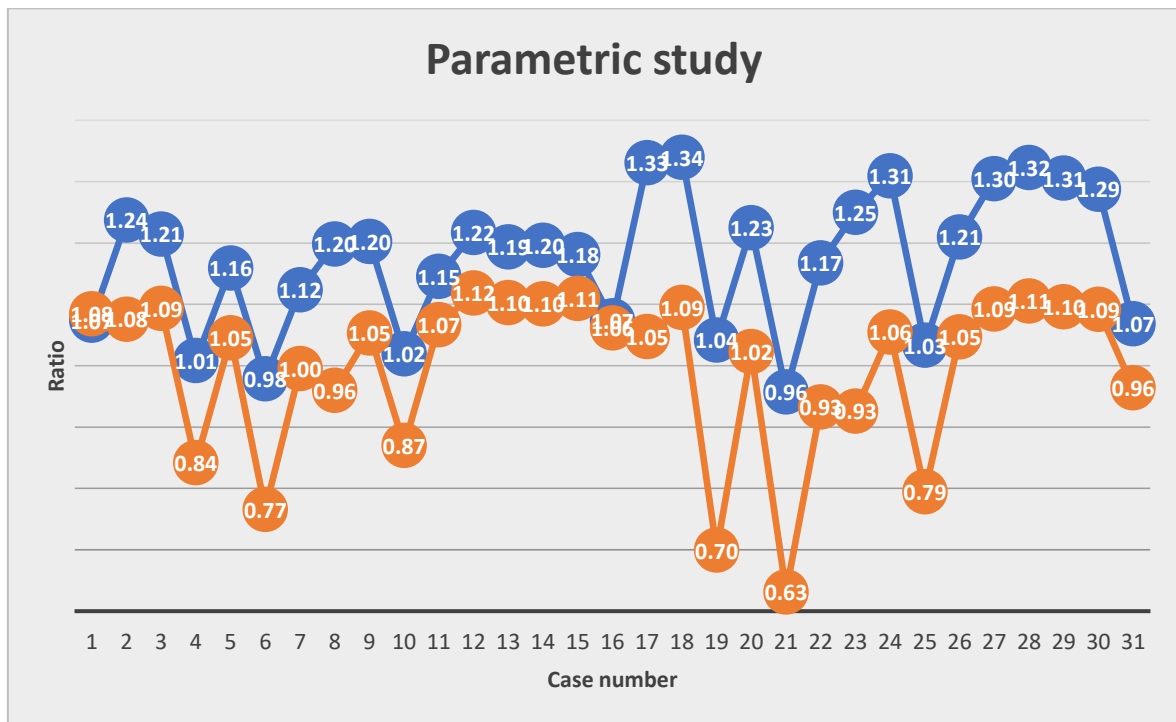

Figure 30: Graph showing the results of parametric study



## 6. CONCLUSION

This master thesis contains detailed numerical investigations of the influence of layered casting and phased construction on the stressing due to self-weight. The investigations are carried out as comparative study in which the occurring stressing due to self-weight without and with regard to the casting and construction process are compared.

The first case studied herein was a massive concrete foundation which is casted in layers. The model was generated with volume elements whereby the presence of the casting layers as well as their stiffness could be controlled by grouping. Although the layers are placed fresh-in-fresh on top of each other, the casting process lasts overall that long that the lower layers developed already significant stiffness before the upper layers do even set. The resulting differences on the present stiffness over the height causes significant changes in the horizontal stressing due to the settlement due to self-weight. In the study it was shown that significant differences in the horizontal stressing at the bottom of the block can be obtained if the layered casting is regarded. In particular, the tensile stressing at the bottom was increased by the consideration of the layered casting with delayed stiffness in comparison to a calculation “all-in-once” by a factor of 2. In the viewed case, this increase would cause an exceeding of the tensile strength leading to cracking or unexpected crack widths if not appropriately addressed in the design. Another important aspect is the horizontal support at the foundation bottom due to horizontal stiffness of the soil. If regarded, the horizontal stresses decrease by factor two, however, this effect should be neglected on the safe side since this requires a similar soil stiffness in horizontal direction as in vertical direction as well as a rigid connection of soil and foundation in the contact area.

The second case is a jointless building construction with two building cores and several floors over the height. The floors are cast subsequently whereby the increasing self-weight with ongoing construction process causes a subsidence cavity in which the whole structure settles. And by this the build-up of a bending moment over the entire height of the building with a tensile force in the foundation slab is presumed. The model was generated with shell elements for all slabs and the walls of the building cores whereas the columns were idealized with tie elements. The construction process and the stiffness of the construction stages was hereby controlled by grouping. Overall, this case showed no significant difference between the cases with and without consideration of the construction process. The reason is the specific form of the subsidence cavity. The initial presumption of a pronounced subsidence

cavity causing a bending moment over the height with a tensile force in the ground slab was not confirmed. The reason is the general homogenization of the subsidence cavity by the introduction of punctual loads from the columns.

Finally, it can be concluded that the conducted research has started to give new insights into soil-structure interaction and influences of load from self-weight in case when more reality corresponding approach of conditions is considered.

## LITERATURE LIST

1. Bastian E. Rapp, Microfluidics: Modeling, Mechanics and Mathematics, <https://doi.org/10.1016/B978-1-4557-3141-1.50032-0> , 03.05.2019.
2. Sofistik.de  
[https://www.fides-dvp.de/fileadmin/user\\_upload/STATIK/Sofistik/Produktblatt/SOFiSTiK\\_Programmstruktur.pdf](https://www.fides-dvp.de/fileadmin/user_upload/STATIK/Sofistik/Produktblatt/SOFiSTiK_Programmstruktur.pdf) , 02.05.2019.
3. Google.com  
[https://www.google.com/search?q=hoover+dam&source=lnms&tbm=isch&sa=X&ved=0ahUKEwiLqeaC4KniAhXrAWMBHTFbC-UQ\\_AUIDigB&biw=1536&bih=722#imgrc=3so9M-hT1knc4M:](https://www.google.com/search?q=hoover+dam&source=lnms&tbm=isch&sa=X&ved=0ahUKEwiLqeaC4KniAhXrAWMBHTFbC-UQ_AUIDigB&biw=1536&bih=722#imgrc=3so9M-hT1knc4M:) , 20.05.2019.
4. Blažević, Maja; Analiza naprezanja tankostjenog spremnika volumena 750 m<sup>3</sup>, Master thesis, Fakultet strojarstva i brodogradnje, Sveučilište u Zagrebu, 2010.
5. Bureau of reclamation, <https://www.usbr.gov/>, 01.09.2019.
6. Gjorgi Kokalanov, Analysis of a concrete face Rockfill dam including concrete face loading and deformation using program package SOFiSTiK, <https://www.researchgate.net/publication/261296224> , 03.05.2019.
7. Sofistik AG, SIR Manual, Version 2018-8, Germany
8. Sorić, Jurica; Metoda konačnih elemenata, Golden marketing-Tehnička knjiga, Zagreb, 2004
9. SOFiMSHA – SOFiSTiK 2018
10. Report browser, Sofistik
11. Eduardo Kausel; Early history of soil–structure interaction, from: [www.elsevier.com/locate/soildyn](http://www.elsevier.com/locate/soildyn), <file:///C:/Users/anamu/Downloads/1-s2.0-S0267726109001754-main.pdf>, 20 November 2009
12. Holtz, Kovacs and Sheahan ; An introduction to Geotechnical engineering, Pearson 2010-10-18, United States, 2010
13. Doc.dr.sc. Arbanas Željko; Mehanika tla, predavanja MT1-06, 2006/2007,
14. Heinrich, Peter Joachim; Schlicke, Dirk, Crack assessment of a very thick and block-like concrete member, Slovak Journal of Civil Engineering, De Gruyter, Vol. 26, 2018, No. 3

**APPENDIX A – INPUT FROM SOFISTIK FOR CASE 1**

**\$ GEOMETRY**

**\$ Concrete block**

```
#define B=16
#define L=64
#define H=16
#define HL=1 $ height of one layer
```

**\$ Soil body**

```
#define LS=($L)*3
#define WS=($B)*3
#define DS=($L)*3
```

**\$ Mesh fineness**

```
#define coarse=10
#define rough=5
#define fine=1
#define veryfine=0.5
#define gdiv=100000
```

**+sys del \$(project).cdb**

**+PROG AQUA urs:1**

```
head
norm EN 1992-2004 unit 0
CONC 1 C 30 mue 0
STEE 2 B 500B
MATE 100 e 25 gam 0
```

end

**+PROG SOFIMSHA urs:2**

```
head soil
syst 3D gdiv $(gdiv)
```

```
let#x (0),($L)-($L)/8),($L),($L)+$L/8),($LS)
let#y (0),($B)-($B)/4),($B),($B)+$B/4),($WS)
let#z (15*$(HL)),(16*$(HL)),(16*$(HL)+$H)/2),(16*$(HL)+$(DS))
```

```
let#te_x ((#x(1)-#x(0))/$(coarse)),((#x(2)-#x(1))/$(fine)),((#x(3)-#x(2))/$(fine)),((#x(4)-#x(3))/$(coarse))
let#te_y ((#y(1)-#y(0))/$(rough)),((#y(2)-#y(1))/$(fine)),((#y(3)-#y(2))/$(fine)),((#y(4)-#y(3))/$(coarse))
let#te_z ((#z(1)-#z(0))/$(veryfine)),((#z(2)-#z(1))/$(fine)),((#z(3)-#z(2))/$(coarse))
```

```
prt#x
prt#y
prt#z
```

```
let#i 0
loop 4
if (#te_x(#i)-div(#te_x(#i),1))<0.5
let#tex(#i) div(#te_x(#i),1)
else
let#tex(#i) div(#te_x(#i),1)+1
endif
let#i #i+1
endloop
prt#tex
```

```
let#i 0
loop 4
if (#te_y(#i)-div(#te_y(#i),1))<0.5
let#tey(#i) div(#te_y(#i),1)
else
let#tey(#i) div(#te_y(#i),1)+1
endif
let#i #i+1
endloop
prt#tey
```

```
let#i 0
loop 3
if (#te_z(#i)-div(#te_z(#i),1))<0.5
let#tez(#i) div(#te_z(#i),1)
else
let#tez(#i) div(#te_z(#i),1)+1
endif
let#i #i+1
endloop
prt#tez
```

SOFiSTiK AG - www.sofistik.de

*\$ Nodes*

```
let#node 100
```

```
let#k 0
loop 5
```

```
let#j 0
loop 5
```

```
let#i 0
loop 4
```

```
let#go 0
```

```
if #i>0
let#go 1
else
```

```
    if (#k<3)&(#j<3)
    let#go 1
    endif
```

endif

```
if #go==1
node #node*(#k+1)+#j*10+#i #x(#k) #y(#j) #z(#i)
let#k_prt (#k+1)+#j*10+#i; prt#k_prt
endif
```

```
let#i #i+1
endloop
```

```
let#j #j+1
endloop
```

```
let#k #k+1
endloop
```

*\$ Volume*

```
let#n 100
```

```
let#k 0
loop 4
```

```
let#j 0
loop 4
```

```
let#i 0
loop 3
```

```
$prt#k; prt#j; prt#i; prt#go
$txb #k #j #i #go
```

```
let#go 0
```

```
if #i>0
let#go 1
let#mno 100
else
```

```
let#mno 1
```

```
if (#k<2)&(#j<2)
let#go 1
endif
```

```
endif
```

```
if #go==1
bric prop mno #mno
grp #mno
bric n1 (#n*(#k+1)+(#j)*10+#i) (#n*(#k+1)+(#j+1)*10+#i) (#n*(#k+2)+(#j+1)*10+#i) (#n*(#k+2)+(#j)*10+#i)
endif
```

```
let#i #i+1
```

```
endloop

let#j #j+1
endloop

let#k #k+1
endloop

let#grp 1

loop 15
grp #grp+1
tran type bric from #grp inc grp dz -$(HL)
let#grp #grp+1
endloop

$ support

mod type node xmin 0 xmax #x(4) ymin 0 ymax #y(4) zmin #z(3) zmax #z(3) fix pz $ px py
mod type node xmin 0 xmax 0 ymin 0 ymax #y(4) zmin 0 zmax #z(3) fix px $ px py
mod type node xmin #x(4) xmax #x(4) ymin 0 ymax #y(4) zmin #z(1) zmax #z(3) fix px $ px py
mod type node xmin 0 xmax #x(4) ymin 0 ymax 0 zmin 0 zmax #z(3) fix py $ px py
mod type node xmin 0 xmax #x(4) ymin #y(4) ymax #y(4) zmin #z(1) zmax #z(3) fix py $ px py

end

+prog ase urs:3
ctrl solv 4

$ all in once
lc 101 dlz 1
end

$ layer-by-layer with immediate stiffness
let#lcnr 201
let#i 0
loop 16

if #i>0
syst plc #lcnr+#i-1
endif

$ as soon as 'grp' is used, all groups are initially switched off
grp 100
grp (1 16 1) facs 0.00001 facd 0 $ all groups switched on but no stiffness and no weight
grp (1 #i+1 1) facs 1 facd 1

lc #lcnr+#i $ dlz 1
end

let#i #i+1
endloop
```



```
$ layer-by-layer with delayed stiffness by one phase
let#lcnr 301
let#i 0
loop 16

  if #i>0
    syst plc #lcnr+#i-1
  endif

  $ as soon as 'grp' is used, all groups are initially switched off

  grp 100
  grp (1 16 1) facs 0.00001 facd 0 $ all groups switched on but no stiffness and no weight
  grp (1 #i+1 1) facs 1 facd 1 $t1 28)

  if #i<15
    grp #i+2 facs 0.0001 facd 1
  endif

  lc #lcnr+#i $ dlz 1
end

let#i #i+1
endloop

end
```

\$ GEOMETRY

\$ Concrete block

```
#define B=16
#define L=64
#define H=16
#define HL=1 $ height of one layer
```

\$ Soil body

```
#define LS=($L)*3
#define WS=($B)*3
#define DS=($L)*3
```

\$ Mesh fineness

```
#define coarse=10
#define rough=5
#define fine=1
#define veryfine=0.5
#define gdiv=100000
```

```
#define gap=0.01
```

+sys del \$(project).cdb

+PROG AQUA urs:1

head

norm EN 1992-2004 unit 0

CONC 1 C 30 mue 0

STEE 2 B 500B

MATE 100 e 25 gam 0

end

+PROG SOFIMSHA urs:2

head soil

syst 3D gdiv \$(gdiv)

```
let#x (0),($L)-($L)/8),($L),($L)+$L/8),($LS)
```

```
let#y (0),($B)-($B)/4),($B),($B)+$B/4),($WS)
```

```
let#z (15*$HL), (16*$HL), (16*$HL)+$H/2), (16*$HL)+$DS)
```

```
let#te_x ((#x(1)-#x(0))/$(coarse)),((#x(2)-#x(1))/$(fine)),((#x(3)-#x(2))/$(fine)),((#x(4)-#x(3))/$(coarse))
```

```
let#te_y ((#y(1)-#y(0))/$(rough)),((#y(2)-#y(1))/$(fine)),((#y(3)-#y(2))/$(fine)),((#y(4)-#y(3))/$(coarse))
```

```
let#te_z ((#z(1)-#z(0))/$(veryfine)),((#z(2)-#z(1))/$(fine)),((#z(3)-#z(2))/$(coarse))
```

prt#x

prt#y

prt#z

```
let#i 0
loop 4
if (#te_x(#i)-div(#te_x(#i),1))<0.5
let#tex(#i) div(#te_x(#i),1)
else
let#tex(#i) div(#te_x(#i),1)+1
endif
```

```
$ Length of partition
let#dx(#i) (#x(#i+1)-#x(#i))/#tex(#i)
```

```
let#i #i+1
endloop
prt#tex
```

```
let#i 0
loop 4
if (#te_y(#i)-div(#te_y(#i),1))<0.5
let#tey(#i) div(#te_y(#i),1)
else
let#tey(#i) div(#te_y(#i),1)+1
endif
```

```
$ Length of partition
let#dy(#i) (#y(#i+1)-#y(#i))/#tey(#i)
```

```
let#i #i+1
endloop
prt#tey
```

```
let#i 0
loop 3
if (#te_z(#i)-div(#te_z(#i),1))<0.5
let#tez(#i) div(#te_z(#i),1)
else
let#tez(#i) div(#te_z(#i),1)+1
endif
let#i #i+1
endloop
prt#tez
```

```
$ Nodes
```

```
let#node 100
```

```
let#k 0
loop 5
```

```
let#j 0
loop 5
```

```
let#i 0
loop 4
```

```
let#go 0

if #i>0
let#go 1
else

  if (#k<3)&(#j<3)
  let#go 1
  endif

endif

if #go==1
node #node*(#k+1)+#j*10+#i #x(#k) #y(#j) #z(#i)
let#k_prt (#k+1)+#j*10+#i; prt#k_prt
endif

let#i #i+1
endloop

let#j #j+1
endloop

let#k #k+1
endloop

$ Volume

let#n 100

let#k 0
loop 4

  let#j 0
  loop 4

    let#i 0
    loop 3

      $prt#k; prt#j; prt#i; prt#go
      $txb #k #j #i #go

      let#go 0

      if #i>0
      let#go 1
      let#mno 100
      else

        let#mno 1

        if (#k<2)&(#j<2)
        let#go 1
        endif

      endif

endif
```

```
if #go==1
bric prop mno #mno
if #mno==1
let#mno 99
endif
grp #mno
bric n1 (#n*(#k+1)+(#j)*10+#i) (#n*(#k+1)+(#j+1)*10+#i) (#n*(#k+2)+(#j+1)*10+#i) (#n*(#k+2)+(#j)*10+#i)
endif
```

```
let#i #i+1
endloop
```

```
let#j #j+1
endloop
```

```
let#k #k+1
endloop
```

*\$ make a gap for free horizontal movement at the bottom of the block*

```
grp 1
tran type bric from 99 inc grp dz -$(gap)
del bric 99 inc grp
```

```
let#grp 1
loop 15
grp #grp+1
tran type bric from #grp inc grp dz -$(HL)
let#grp #grp+1
endloop
```

*\$ coupling of contact phase between block and soil by searching for nodenumbers of nodes which are directly*

*grp 200 300 \$ surface of the soil*

```
let#xx 0
```

```
let#k 0
loop 2
```

```
loop #tex(#k)
```

```
let#yy 0
let#j 0
loop 2
```

```
loop #tey(#j)
```

```
getn #xx #yy #z(1) n1  
getn #xx #yy #z(1)-$(gap) n2
```

```
node no #n1 nr1 #n2 fix kppz
```

```
let#yy #yy+#dy(#j)  
endloop
```

```
let#j #j+1  
endloop
```

```
let#xx #xx+#dx(#k)  
endloop
```

```
let#k #k+1  
endloop
```

```
$ support
```

```
mod type node xmin 0 xmax #x(4) ymin 0 ymax #y(4) zmin #z(3) zmax #z(3) fix pz $ px py  
mod type node xmin 0 xmax 0 ymin 0 ymax #y(4) zmin -$(gap) zmax #z(3) fix px $ px py  
mod type node xmin #x(4) xmax #x(4) ymin 0 ymax #y(4) zmin #z(1) zmax #z(3) fix px $ px py  
mod type node xmin 0 xmax #x(4) ymin 0 ymax 0 zmin -$(gap) zmax #z(3) fix py $ px py  
mod type node xmin 0 xmax #x(4) ymin #y(4) ymax #y(4) zmin #z(1) zmax #z(3) fix py $ px py
```

```
end
```

```
+prog ase urs:3  
ctrl solv 4
```

```
$ all in once  
lc 101 dlz 1  
end
```

```
$ layer-by-layer with immediate stiffness
```

```
let#lcnr 201  
let#i 0  
loop 16
```

```
if #i>0  
syst plc #lcnr+#i-1  
endif
```

```
$ as soon as 'grp' is used, all groups are initially switched off
```

```
grp 100,200  
grp (1 16 1) facts 0.00001 facd 0 $ all groups switched on but no stiffness and no weight  
grp (1 #i+1 1) facts 1 facd 1
```

```
lc #lcnr+#i $ dlz 1
```

end

let#i #i+1  
endloop

*\$ layer-by-layer with delayed stiffness by one phase*

let#lcnr 301

let#i 0

loop 16

if #i>0

syst plc #lcnr+#i-1

endif

*\$ as soon as 'grp' is used, all groups are initially switched off*

grp 100,200

grp (1 16 1) facs 0.00001 facd 0 *\$ all groups switched on but no stiffness and no weight*

grp (1 #i+1 1) facs 1 facd 1 *\$t1 28)*

if #i<15

grp #i+2 facs 0.0001 facd 1

endif

lc #lcnr+#i *\$ dlz 1*

end

let#i #i+1  
endloop

end

Default design code is EuroNorm EN 1992-1-1:2004 Concrete Structures (Europe) V 2018  
Structure and Tab.7.1N: AN (Buildings)  
Snow load zone : 1

**Materials**

Mat	Classification
1	C 30/37 (EN 1992)
2	B 500 B (EN 1992)
100	Elastic Material

Educational Version



soil

**Groups**

Grp	number	Type	min-no	max-no	Designation
1	168	BRIC	100001	100168	
2	168	BRIC	200001	200168	
3	168	BRIC	300001	300168	
4	168	BRIC	400001	400168	
5	168	BRIC	500001	500168	
6	168	BRIC	600001	600168	
7	168	BRIC	700001	700168	
8	168	BRIC	800001	800168	
9	168	BRIC	900001	900168	
10	168	BRIC	1000001	1000168	
11	168	BRIC	1100001	1100168	
12	168	BRIC	1200001	1200168	
13	168	BRIC	1300001	1300168	
14	168	BRIC	1400001	1400168	
15	168	BRIC	1500001	1500168	
16	168	BRIC	1600001	1600168	
100	11492	BRIC	10000001	10011492	
200	84	KINE	20000001	20000084	

Grp primary group number  
 number number of elements within group  
 Type element type  
 min-no,max-no minimum/maximum element number

**Summary of volume elements**

**Groups**

Grp	TotVolume [m3]	TotWeight [t]	Material
1	1024.0000	2560.000	1
2	1024.0000	2560.000	1
3	1024.0000	2560.000	1
4	1024.0000	2560.000	1
5	1024.0000	2560.000	1
6	1024.0000	2560.000	1
7	1024.0000	2560.000	1
8	1024.0000	2560.000	1
9	1024.0000	2560.000	1
10	1024.0000	2560.000	1
11	1024.0000	2560.000	1
12	1024.0000	2560.000	1
13	1024.0000	2560.000	1
14	1024.0000	2560.000	1
15	1024.0000	2560.000	1
16	1024.0000	2560.000	1
100	1769472.0458	0.000	100
Sum	1785856.0466	40960.002	

Grp primary group number

## **APPENDIX B – INPUT FROM SOFISTIK FOR CASE 2**

*\$ GEOMETRY*

```
#define a=7    $ column range
#define h=3.5  $ height of one storey

#define n=11   $ number of partitions in x direction
#define m=3    $ number of partitions in y direction
#define o=7    $ number of partitions in z direction

#define L=($a)*$(n)  $ span in x direction
#define B=($a)*$(m)  $ span in y direction
#define H=($h)*$(o)  $ span in z direction

#define tslab=0.2    $ [m]
#define tcore=0.3    $ [m]
#define tbase=0.4    $ [m]
#define bcol=0.4     $ [m]
```

**+PROG AQUA urs:1**

HEAD

*\$ Materials*

```
NORM EN 1992-2004 UNIT 0
CONC 1 C 30 mue 0
STEE 2 B 500B
```

*\$ Bore profile*

```
BORE 3 X 0.0 Y 0.0 Z 0.0 NZ 1.0
BLAY S 0.0 ES 5000 VARI cons
BLAY S 50.0 ES 5000 VARI cons
```

*\$ Cross section*

```
SREC NO 1 H $(bcol) B $(bcol) MNO 1 MRF 2 REF C
```

end

**+PROG SOFIMSHA urs:2**

HEAD

*\$ Global system*

```
SYST 3D GDIR POSZ GDIV 10000
```

```
let#x (0),$(L)
let#y (0),$(B)
let#z (0),$(H)
```

```
let#dx ((#x(1)-#x(0))/$(n))
```

```
let#dy ((#y(1)-#y(0))/$ (m))  
let#dz ((#z(1)-#z(0))/$ (o))
```

*\$ Nodes*

```
let#node 100  
  
let#xx 0  
let#k 0  
loop (($ (n))+1)  
  
let#yy 0  
let#j 0  
loop (($ (m))+1)  
  
let#zz 0  
let#i 0  
loop (($ (o))+1)
```

SOFiSTiK AG - www.sofistik.de

```
node #node*(#k+1)+#j*10+#i #xx #yy -#zz  
  
let#zz #zz+#dz  
let#i #i+1  
endloop  
  
let#yy #yy+#dy  
let#j #j+1  
endloop  
  
let#xx #xx+#dx  
let#k #k+1  
endloop
```

*\$ Slab*

```
let#node 100  
  
let#k 0  
loop ($ (n))  
  
let#j 0  
loop ($ (m))  
  
let#i 0  
loop ($ (o)+1)  
  
let#prt1 (#node*(#k+1)+(#j)*10+#i) ; prt#prt1  
let#prt2 (#node*(#k+1)+(#j+1)*10+#i) ; prt#prt2  
let#prt3 (#node*(#k+2)+(#j+1)*10+#i) ; prt#prt3
```

```
let#prt4 (#node*(#k+2)+(#j)*10+#i) ; prt#prt4
```

```
let#grp 100  
grp #grp+#i
```

```
if #i==0  
quad n1 #prt1 n2 #prt2 n3 #prt3 n4 #prt4 m 4 n 4 mno 1 mrf 2 T $(tbase)  
else  
quad n1 #prt1 n2 #prt2 n3 #prt3 n4 #prt4 m 4 n 4 mno 1 mrf 2 T $(tslab)  
endif
```

```
let#i #i+1  
endloop
```

```
let#j #j+1  
endloop
```

```
let#k #k+1  
endloop
```

```
$ Column
```

```
$grp 200
```

```
let#node 100
```

```
let#k 0  
loop ($(n)+1)
```

```
let#j 0  
loop ($(m)+1)
```

```
let#i 0  
loop ($(o))
```

```
let#grp 200  
grp #grp+#i+1
```

```
beam na (#node*(#k+1)+(#j)*10+#i) ne (#node*(#k+1)+(#j)*10+(#i+1)) ncs 1 drz
```

```
let#i #i+1  
endloop
```

```
let#j #j+1  
endloop
```

```
let#k #k+1  
endloop
```

```
$ Core
```

\$grp 300

let#node 100

let#i 0

loop (\$(o))

let#grp 300  
grp #grp+#i+1

let#prt1 (#node\*(2)+(1)\*10+#i) ; prt#prt1  
let#prt2 (#node\*(3)+(1)\*10+#i) ; prt#prt2  
let#prt3 (#node\*(3)+(1)\*10+#i+1) ; prt#prt3  
let#prt4 (#node\*(2)+(1)\*10+#i+1) ; prt#prt4

quad fit n1 #prt1 n2 #prt2 n3 #prt3 n4 #prt4 n 4 mno 1 mrf 2 T \$(tcore)

let#prt1 (#node\*(2)+(2)\*10+#i) ; prt#prt1  
let#prt2 (#node\*(3)+(2)\*10+#i) ; prt#prt2  
let#prt3 (#node\*(3)+(2)\*10+#i+1) ; prt#prt3  
let#prt4 (#node\*(2)+(2)\*10+#i+1) ; prt#prt4

quad fit n1 #prt1 n2 #prt2 n3 #prt3 n4 #prt4 n 4 mno 1 mrf 2 T \$(tcore)

let#prt1 (#node\*(2)+(1)\*10+#i) ; prt#prt1  
let#prt2 (#node\*(2)+(2)\*10+#i) ; prt#prt2  
let#prt3 (#node\*(2)+(2)\*10+#i+1) ; prt#prt3  
let#prt4 (#node\*(2)+(1)\*10+#i+1) ; prt#prt4

quad fit n1 #prt1 n2 #prt2 n3 #prt3 n4 #prt4 n 4 mno 1 mrf 2 T \$(tcore)

let#prt1 (#node\*(3)+(1)\*10+#i) ; prt#prt1  
let#prt2 (#node\*(3)+(2)\*10+#i) ; prt#prt2  
let#prt3 (#node\*(3)+(2)\*10+#i+1) ; prt#prt3  
let#prt4 (#node\*(3)+(1)\*10+#i+1) ; prt#prt4

quad fit n1 #prt1 n2 #prt2 n3 #prt3 n4 #prt4 n 4 mno 1 mrf 2 T \$(tcore)

let#i #i+1  
endloop

tran quad from 301 to (300+\$(o)) inc grp dx ((\$n)-3)\*\$(a)

*\$ support in horizontal direction of half space has no horizontal stiffness*

node 100 fix pxy  
node 130 fix px

end

**+prog sofiload urs:7**  
head

*\$ all in once*  
lc 101 dlz 1

end

**+prog hase urs:4**

head

*\$HALF TYPE COOR fakx 0.4 faky 0.4 fakz 1*  
*\$ in case of no horizontal interaction*  
HALF TYPE COOR fakx 0. faky 0. fakz 1  
BORE 3

end

**+prog ase urs:5**

head

CTRL OPT SOLV VAL 4

SYST PROB LINE  
STEX *\$ external stiffness*

LC 101  
END

**+prog ase urs:3**

head

ctrl solv 4

ctrl cant 2 *\$ displacement of nodes of new phases according to*  
*\$ deformation of nodes of prior phases the construction process*

STEX

*\$ phased construction*

let#lcnr 200

let#i 0

loop ( $\$(o)$ ) *\$ only 7 loops since we have only seven floors;*  
*\$ the 8th loop would only switch on axial stiffness of the top floor, which*  
*\$ makes no difference in the result*

*\$ LCs upper slabs on top of primary loadcase*

if #i>0

syst plc #lcnr+#i-1

endif

*\$ ground slab and vertical elements of first floor are initial seating*

*\$ and in the following loadcase, this is shifted one floor above*

grp 100 facd 1

grp (201 201+#i 1) facd 1

grp (301 301+#i 1) facd 1

*\$ in the current loadcase, also the slab above exists already, whereby the actual slab has weight but no a:*

grp 101+#i facd 1

```
grp2 101+#i quea 0.01 $ command to reduce axial stiffness
```

```
if #i>0  
grp (101 100+#i 1) facd 1  
grp2 (101 100+#i 1) quea 1 $ command to reduce axial stiffness  
endif
```

```
lc #lcnr+#i $ dLz 1  
end
```

```
let#i #i+1  
endloop
```

```
end
```

```
+prog bemess urs:8
```

```
para -  
para 100 du 10 dl 10 asu 1 asl 1
```

```
end
```

```
+prog bemess urs:9
```

```
ctrl sls rmod supe lcr 500  
crac wk 0.2
```

```
grp 100  
lc 101
```

```
end
```

```
+prog bemess urs:10
```

```
ctrl sls rmod supe lcr 501  
crac wk 0.2
```

```
grp 100  
let#lc (200+$(o)-1) ; lc #lc
```

```
end
```

```
+PROG HASE urs:6 $ Evaluate soil response  
head Evaluate soil response
```

```
LC ALL
```

```
SELP zr 10  
SELP zr 15  
SELP zr 20  
SELP zr 30
```

```
SELP LCST  
SELP BRIC
```

```
end
```





Default design code is EuroNorm EN 1992-1-1:2004 Concrete Structures (Europe) V 2018  
Structure and Tab.7.1N: AN (Buildings)  
Snow load zone : 1

**Materials**

Mat	Classification
1	C 30/37 (EN 1992)
2	B 500 B (EN 1992)

Cross section No. 1 - B/H = 40 / 40 cm

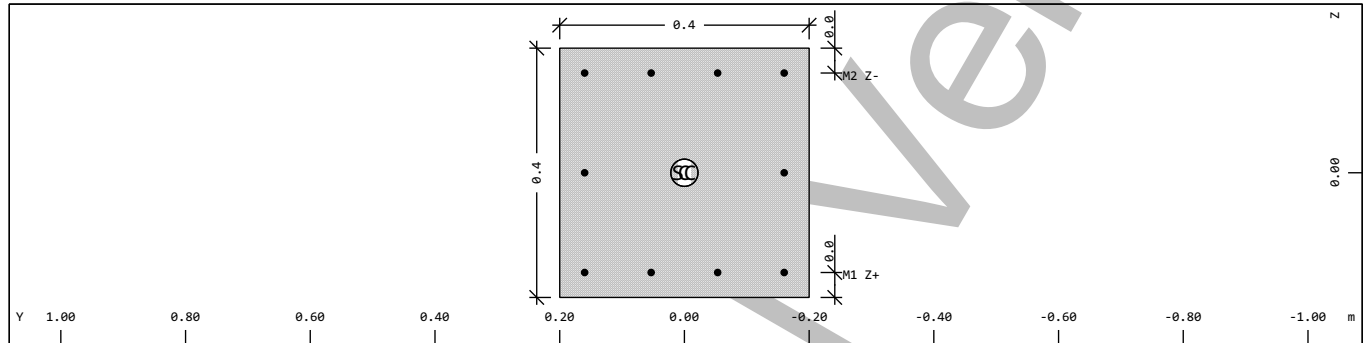

Cross section No. 1 - B/H = 40 / 40 cm

**Static properties of cross section**

SNo	Mat	A[m2]	Ay[m2]	Iy[m4]	yc[m]	ysc[m]	E[MPa]	g[kg/m]	I-1[m4]
	MRF	It[m4]	Az[m2]	Iz[m4]	zc[m]	zsc[m]	G[MPa]		I-2[m4]
			Ayz[m2]	Iyz[m4]					$\alpha$ [°]
1	1	1.6000E-01	1.333E-01	2.133E-03	0.000	0.000	32837	400.0	
	2	3.599E-03	1.333E-01	2.133E-03	0.000	0.000	16418	(CENTR)	
= B/H = 40 / 40 cm									
= (D-As 40 / 40 mm)									
SNo	section number			yc[m],zc[m]	ordinate of elastic centroid				
Mat	material number			ysc[m],zsc[m]	ordinate of shear centre				
A[m2]	sectional area			E[MPa]	Young's modulus				
Ay[m2],Az[m2],Ayz[m2]	transverse shear deformation area			g[kg/m]	weight per length				
Iy[m4],Iz[m4],Iyz[m4]	bending moment of inertia								
I-1[m4],I-2[m4], $\alpha$ [°]	principal moments of inertia and angle of the principal axes								
MRF	reinforcement material number								
It[m4]	torsional moment of inertia								
G[MPa]	Shear modulus								

**Reinforcement global values**

Layer	Mref	Mat	As	As-min	As-max	D	yr	zr	L-tors	N-p	My-p	Mz-p
			[cm2]	[cm2]	[cm2]	[mm]	[m]	[m]	[m]	[kN]	[kNm]	[kNm]
M1	Z+	1	2	3.16	0.00		10	0.000	0.160	0.320		
M2	Z-	1	2	3.16	0.00		10	0.000	-0.160	0.320		
M3	Y+-	1	2	1.58	0.00	1.58	10	0.000	0.000	0.640		
Layer	layer of reinforcement		D			bar diameter						
Mref	embedding reference material		yr,zr			ordinate of elastic centroid						
Mat	material number		L-tors			torsional effective length						
As	reinforcement area		N-p			prestress normal force						
As-min	minimum reinforcement area		My-p,Mz-p			prestress bending moment						
As-max	maximum reinforcement area											

**Bore Profile NoP 3**

X[m]	Y[m]	Z[m]	dX[-]	dY[-]	dZ[-]	$\alpha$ [°]	Hgw1[m]	Hgwh[m]
0.000	0.000	0.000	0.000	0.000	1.000	0.0	0.000	0.000
X[m],Y[m],Z[m]		coordinates of the start point			Hgw1[m]		lowest ground water level	
dX[-],dY[-],dZ[-]		direction of the bore profile			Hgwh[m]		highest ground water level	
$\alpha$ [°]		rotation angle of the local axes						

**Soil layer**

s	Mat	Es	dEs	VARI	MUE	Pmax	Pma1	c	$\phi$	$\gamma$	$\gamma_a$
[m]	[-]	[kN/m <sup>2</sup> ]	[kN/m <sup>2</sup> ]		[-]	[kN/m <sup>2</sup> ]	[kN/m <sup>2</sup> ]	[kN/m <sup>2</sup> ]	[°]	[kN/m <sup>3</sup> ]	[kN/m <sup>3</sup> ]
0.000		5000.00		CONS							
50.000		5000.00		CONS							

s	ordinate of the profile axis	Pmax	maximum pressure at pile foot
Mat	material number	Pma1	maximum lateral pressure
Es	Oedometer stiffness	c	Cohesion
dEs	increment of the compression modulus	$\phi$	Friction angle
VARI	type of the variation of the compression modulus	$\gamma$	specific weight
MUE	Poisson's ratio	$\gamma_a$	specific weight under buoyancy

Educational Version

**Groups**

Grp	number	Type	min-no	max-no	Designation
100	528	QUAD	1000001	1000528	
101	528	QUAD	1010001	1010528	
102	528	QUAD	1020001	1020528	
103	528	QUAD	1030001	1030528	
104	528	QUAD	1040001	1040528	
105	528	QUAD	1050001	1050528	
106	528	QUAD	1060001	1060528	
107	528	QUAD	1070001	1070528	
201	48	BEAM	2010001	2010048	
202	48	BEAM	2020001	2020048	
203	48	BEAM	2030001	2030048	
204	48	BEAM	2040001	2040048	
205	48	BEAM	2050001	2050048	
206	48	BEAM	2060001	2060048	
207	48	BEAM	2070001	2070048	
301	64	QUAD	3010001	3010064	
302	64	QUAD	3020001	3020064	
303	64	QUAD	3030001	3030064	
304	64	QUAD	3040001	3040064	
305	64	QUAD	3050001	3050064	
306	64	QUAD	3060001	3060064	
307	512	QUAD	3070001	3070512	
Grp	primary group number	Type	element type		
number	number of elements within group		min-no,max-no	minimum/maximum element number	

